

Electronic Balance Instruction Manual

ATX series 

ATX224 · ATX124 · ATX84

ATY series 

ATY224 · ATY124 · ATX64

Read the instruction manual thoroughly before you use the product. Keep this instruction manual for future reference.

 **SHIMADZU CORPORATION**
KYOTO JAPAN

ANALYTICAL & MEASURING INSTRUMENTS DIVISION

Name and Function of Components
Installation

BEFORE
WEIGHING

Weighing
Outputting Weight Readings
Selecting the Display
Ending Weighing

USING THE
BALANCE

Menu Settings
Calibration
Functions Relating to Taring
Adjusting Response and Stability
Setting Units
Application Function Mode
Comparator Function
Connection and Communication
with Peripheral Devices

USING MORE CONVENIENTLY

Maintaining the Balance
Inspection
About Weights

MAINTENANCE

What to Do If...
Responding to Messages...

TROUBLESHOOTING

Turning the Power ON and OFF
Changing the Password
GLP Output Function
Specifications
Maintenance Parts
List of Functions That Can Be Used
in Combination
Menu Map

FOR YOUR
INFORMATION



Requests

- Provide this manual to the next user in the event that the instrument is transferred.
- To ensure safe operation, contact your Shimadzu Balance representative for installation, adjustment, or reinstallation after moving the instrument to a different site.



Notices

- The content of this manual is subject, without notice, to modifications for the sake of improvement.
- Every effort has been made to ensure that the content of this manual was correct at the time of creation. However, in the event that any mistakes or omissions are discovered, it may not be possible to correct them immediately.
- The copyright of this manual is owned by Shimadzu Corporation. Reproduction and duplication of whole or part of the content without permission of the company are strictly prohibited.
© 2009-2013 Shimadzu Corporation. All rights reserved.
- "Microsoft", "Windows", and "Excel" are registered trademarks of Microsoft Corporation of the U.S.A. in the United States and other countries. All other company names and product names that appear in this manual are trademarks or registered trademarks of the companies concerned. Note that TM and [®] indications are not used.
- The company names, organization names and product names in this manual are trademarks or registered trademarks of the companies and organizations concerned.
- Shimadzu does not guarantee that the WindowsDirect communication function will operate without problems on all PCs. Shimadzu will accept no responsibility for any trouble that arises as a result of using this function. You are recommended to back up all important data and programs in advance.

Introduction

Thank you for purchasing a Shimadzu ATX/ATY series electronic balance.

The ATX/ATY series models are high performance electronic balances that we confidently recommend based on over 90 years of precision balance manufacture. While these models are of course capable of fast and accurate weighing, the models all use the Unibloc cells that Shimadzu started using for electronic balances in 1989, improv the reliability of the balances still further.

These balances also feature a variety of other functions that make it more convenient for customers to use them for their own applications, including the WindowsDirect communication function, which enables measuring results to be transferred to a PC without installing any software.

To ensure that you can make full use of the performance and functions of your ATX/ATY series balance, read this instruction manual carefully and use the balance correctly in accordance with the directions in the manual. When you have finished reading the manual, keep it in a safe place together with the balance so that you can refer to it at any time.

For information on the following points, please contact your Shimadzu Balance representative.

- Product warranty
- After service

How to Find the Information You Need

This manual allows you to search for a function or operating procedure in a number of ways.

- "Cover index"
Search for the information by thumbing through the manual.
- "What You Can Do", page 6
Search for what you want to do.
- "Menu Map", page 143
Search quickly for the menu option you want to use.
- Search for information based on its order of appearance in the manual.
- "Index", page 148
Search for information based on a key word.

◆ Conventions used in menu operations

The instruction manual describes menu operations in a simplified form.

Example:

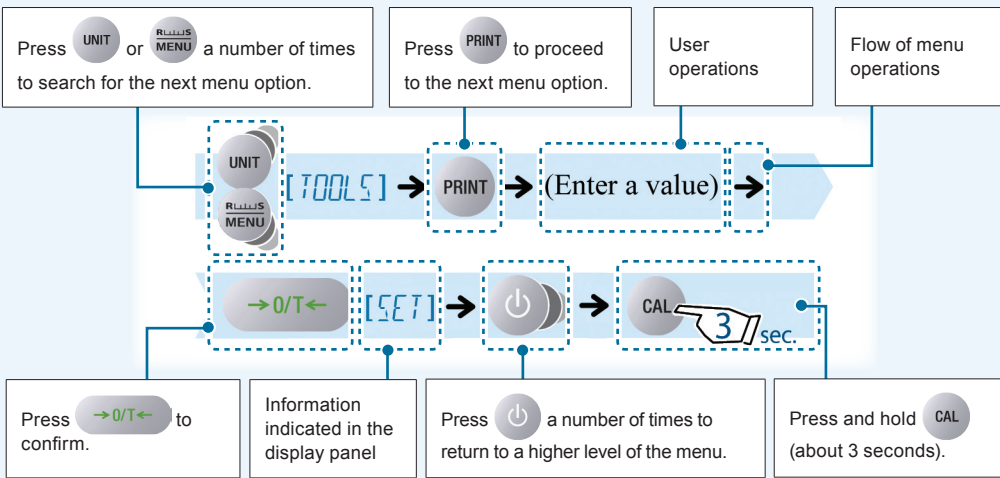

◆ Conventions used for the display panel

This instruction manual depicts the display panel in relation to particular operating procedures.

The actions of the display panel (flashing, lighting up, confirmation) are shown in the following way.

- Flashing



- Lit



- Confirmation



◆ Example page

Linked to the cover index (right-hand pages only)

Index

Notes
Information to help use the balance correctly

Reference

Menu operation

Explanation of terms

Depiction of the display

WindowsDirect Communication Function

In any Windows application (e.g. Excel or the weight input window of an analytical device), the numerical value displayed at the balance can be transferred to the cursor position just as if it had been entered from the keyboard.

What to do if...

- ◆ On installing communications software in the PC and attempting communications, it is not possible to use the WindowsDirect communication function even though the OS is Windows.
- ◆ Perform communications setting as described in "User-Specified Settings" (page 109).
- ◆ When transferring the balance from a PC, you must use command codes for programming (page 103).

Setting the Function

- ◆ Making the settings at the balance

- 1** Press **PRINT** for about 3 seconds in the weighing mode.
This opens the output menu.
- 2** Select WindowsDirect communication.
[WIN] → [PRINT] (Select the output data format.)

When "WIN" has been selected:
- 3** Confirm and return to the weighing mode.
[ENT] → [SET] → [PRINT]

This completes the setting procedure at the balance.

Continued on next page

Continued on next page

The symbol shown in the figure below appears at the head of the next page.

The title of the previous page appears here.



What You Can Do

This section lets you search for a method you would like to try or a function you want to know about.

Various weighing methods

- I want to weigh up to a fixed quantity by adding increments of the same sample (item to be weighed: powder, liquid, etc.) a little at a time.

Pouring Mode → page 69

- I want to make fine adjustments during weighing, like increasing the reaction speed of the display or stabilizing the display.

Easy Setting → page 70

- I want to use the balance to count items.
- I want to set unit weights (the weight of a single piece of the item being weighed) for multiple samples in advance.

Piece Counting → page 81

- I want to weigh in percentages.

Percentage Weighing → page 86

- I want to weigh a fixed amount of each of a number of different samples (items to be weighed: powder, liquid, etc.) and to mix these samples according to a formula.

Formulation → page 90

- I want to check excess or deficiency with respect to a target value and make "pass or fail" judgments accordingly.

Comparator Function → page 96

- I want to adjust the conditions under which the stability mark lights up.

Adjusting the Stability Mark → page 74

Zero point, and taring

- I want to stabilize the display at zero when an empty sample container is placed on the pan.

Zero Tracking Function → page 63

- I want to automatically return the display to zero after weighing.

Auto Zero Function → page 64

- I want to automatically tare the balance (set the display to zero) after outputting a weight reading.

Auto Tare Function → page 66

- I want to tare the balance without waiting for the stability mark to light up.

Zero / Tare Timing Change Function → page 67

Calibration

- I want to adjust the balance so that it is very accurate after stabilization.

Span Calibration and Adjustment ➔ page 54

- I want to carry out calibration and output a record.

Leaving a Record of Calibration ➔ page 59

Printing / output

- I want to send data to a PC (e.g. to Excel).

WindowsDirect Communication Function ➔ page 105

- After weighing, I want to output automatically upon stabilization.

Auto Print Function ➔ page 100

- I want to output data continuously.

Continuous Output Function ➔ page 104

- I want to output data either immediately or after stabilization.

Output Timing Change Function ➔ page 123

- I want to change the format of the decimal point (comma or period) in the output data.

Selecting the Decimal Point Display Symbol ➔ page 37

- I want to add the balance model name, ID and other information to weight readings.

GLP Output Function ➔ page 135

Miscellaneous

- I want to display weights in units other than g (grams).

Switching Units ➔ page 35

Setting the Units ➔ page 76

- I want the power to turn off automatically when I am not using the balance.

Auto Power-Off Function ➔ page 132

- I want to go directly into weighing mode when the power is switched ON.

Setting the Startup Display ➔ page 133

Safety Precautions

To be strictly observed

To ensure that you use the balance safely and correctly, read the following precautions carefully and observe them.

The levels of danger and damage that will arise if the balance is used incorrectly are classified and indicated as shown below.



CAUTION

Indicates a potentially hazardous situation which, if not avoided, may result in minor to moderate injury or equipment damage.

Precautions are classified and explained by using one of the symbols below, depending on the nature of the precaution.



Instructions

Indicates an action that must be performed.



Prohibitions

Indicates an action that must NOT be performed

CAUTION



Prohibitions

Never disassemble, modify or attempt to repair this product or any accessory.

You could sustain an electric shock or the product could operate abnormally.
If you believe that the balance has failed, contact your Shimadzu representative.



Prohibitions

Do not use the balance outdoors or anywhere where it will be exposed to water.

You could sustain an electric shock or the product could operate abnormally.



Instructions

**Use the balance with the correct power supply and voltage.
Use the balance with the attached AC adapter.**

Using the balance with an incorrect power supply or voltage will lead to fire or trouble with the balance.
Note also that if the power supply or voltage is unstable or if the power supply capacity is insufficient, it will not be possible to obtain satisfactory performance from the balance.



Instructions

If you detect anything abnormal (e.g. a burning smell) disconnect the AC adapter immediately.

Continuing to use the balance with an abnormality could lead to fire or an electric shock.



Prohibitions

Do not connect anything other than peripheral devices specified by Shimadzu to the balance's connector.

If you do, the balance may stop working normally.
In order to avoid trouble, always connect peripheral devices in accordance with the directions in this manual.



Prohibitions

Do not use the balance anywhere exposed to explosive, combustible or corrosive gases.

This could cause fire or trouble.

Precautions on Use



Prohibitions

Avoid locations where the balance will be exposed to any of the following.

You may not be able to obtain correct weight readings.

- Air flow from an air conditioner, ventilator, door or window
- Extreme temperature changes
- Vibration
- Direct sunlight
- Dust, fine particles, electromagnetic waves or a magnetic field

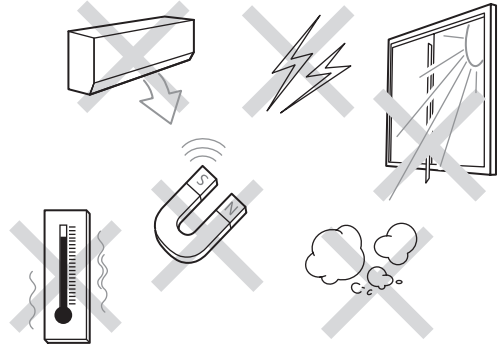

Instructions

Install the balance on a strong and stable flat table or floor in the room.

Placing the balance in an unstable site could lead to injury or trouble with the balance.

When selecting the installation site, take into account the combined weight of the balance and the item to be weighed.



Instructions

Treat the balance with care and respect.

The balance is a precision instrument. Subjecting it to impacts could cause it to fail.

When moving the balance, remove fixing of the glass door, pan, pan supporter and pan rings. Grasp it firmly with both hands to carry it.

If the balance has to be stored for a long time, store it in the packaging box in which it was delivered.



Instructions

After a power outage, turn the power back ON.

When a power outage occurs, the power is shut off automatically. Therefore, begin operation from "Turning the Power ON" (🔌 page 29) again.



Instructions

Use the correct weighing units.

Using incorrect weighing units can lead to accidents as a result of weighing errors.

Check that the weighing units are correct before starting weighing.

Shimadzu Balances and 21 CFR Part 11

21 CFR Part 11

21 CFR Part 11, Electronic Records, Electronic Signatures, Final Rule (often referred to as Part 11) is the United States Food and Drug Administration (FDA) regulation affecting computer resources and electronic records that are used for any document that is required to be kept and maintained by FDA regulations.

Requirements concerning computer resources security are key elements in Part 11.

The controls implemented as a result of security related requirements are intended to result in trusted records.

Shimadzu CLASS-Balance Agent

Shimadzu provides a means for compliance with 21 CFR Part 11 with Shimadzu CLASS-Balance Agent software, part of a comprehensive laboratory data management system, Shimadzu CLASS Agent.

Ask your Shimadzu representative about it.

Shimadzu WindowsDirect

When Shimadzu balances are integrated with laboratory software by means of our WindowsDirect function, no communication software is required or used.

The Shimadzu balance functions as a primary device in the system, just as a keyboard, mouse or other data entry hardware does.

For this reason, system validation and compliance may be greatly simplified with the use of Shimadzu balances.

Two-way Communication

Shimadzu balances have always been computer friendly and they can be set up for bi-directional communication as part of a fully automated production system or LIMS.

This manual includes the command codes and information needed by programmers to integrate Shimadzu balances with their software.

Action for Environment (WEEE)

To all user of Shimadzu equipment in the European Union:

Equipment marked with this symbol indicates that it was sold on or after 13th August 2005, which means it should not be disposed of with general household waste. Note that our equipment is for industrial/professional use only.

Contact Shimadzu service representative when the equipment has reached the end of its life. They will advise you regarding the equipment take-back.

With your co-operation we are aiming to reduce contamination from waste electronic and electrical equipment and preserve natural resource through re-use and recycling.

Do not hesitate to ask Shimadzu service representative, if you require further information.

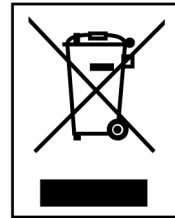

WEEE Mark

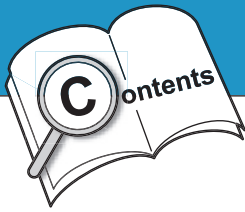

Table of Contents

1 BEFORE WEIGHING 18

Name and Function of Components	18
■ Main body	18
■ Operation Keys	19
■ Display Panel	20
■ Numeric value area	21
Installation	22
■ Choosing the Installation Site	22
■ Unpacking and Delivery Inspection	23
■ Installing the Components	24
■ Adjusting the Level of the Balance	24
■ Turning the Power ON	26
■ Warming Up	27
■ Performing Span Calibration	28

2 USING THE BALANCE 32

Weighing	32
Outputting Weight Readings	34
Selecting the Display	35
■ Switching Units	35
■ Selecting the Minimum Number of Displayed Digit (1d/10d display)	35
■ Selecting the Decimal Point Display Symbol	37
Ending Weighing	39
■ Turning the Power OFF	39

3 MENU SETTINGS 40

What Is the Menu?	40
■ The Structure of the Menu	40
■ Menu Map	41
■ Instruction Manual	41
■ Menu Operation Key Symbol	41
Basic Menu Operations	42

Entering Numerical Values	43
■ Changing the Numerical Value	43
■ Changing the Position of the Decimal Point	44
Convenient Functions for Menu Setting	45
■ Returning to the Default Settings (Menu Reset)	45
■ Prohibiting Changes to the Menu Settings (Menu Lock)	46
■ Outputting the Menu Setting Information	47

4 CALIBRATION 48

Before Starting Calibration.....	48
Automatic calibration (ATX only)	50
Announcement of calibration request (ATY only)	51
Span Calibration and Adjustment	52
Calibration of the Internal Weight (ATX Only)	56
Leaving a Record of Calibration	59
■ Example Printout of a Calibration Record	59
■ Setting Output of a Calibration Record	60
■ Setting a Balance ID	61

5 FUNCTIONS RELATING TO TARING 62

Zero Tracking Function	63
Auto Zero Function	64
Auto Tare Function	66
Zero / Tare Timing Change Function	67

6 ADJUSTING RESPONSE AND STABILITY 68

Selecting the Weighing Mode	69
■ Selecting the General Weighing Mode	69
■ Selecting the Pouring Mode	69
Easy Setting of Response and Stability	70

Adjusting the Stability Mark	72
■ Setting the Stability Detection Range	72
■ Setting the Stability Mark Lighting Timing	73

7 SETTING UNITS 76

■ Units That Can Be Displayed and Conversion Factors	76
Selecting Units to Display	77
Setting User-Specified Units	78
■ Conversion Factors	78
■ Minimum Indication	79

8 APPLICATION FUNCTION MODE 80

Counting Pieces by Weight (Piece Counting)	81
■ Preparation for Piece Counting (Including Setting the Unit Weight)	81
■ Counting Numbers of Pieces	84
■ Changing a Unit Weight, or Adding a New Unit Weight	85
Percentage Weighing	86
■ Preparation for Percentage Weighing	86
■ Weighing Percentages	89
Formulation	90
■ Performing Formulation	90
■ Outputting Component Numbers	93
■ Outputting the Gross Weight	94

9 COMPARATOR FUNCTION 96

Target Mode	96
Checkweighing Mode	98

10 CONNECTION AND COMMUNICATION WITH PERIPHERAL DEVICES 100

Convenient Functions Relating to Output	100
■ Printing / Outputting Automatically (Auto Print Function)	100
■ Printing / Outputting Continuously (Continuous Output Function)	102
WindowsDirect Communication Function	105
■ What Is the WindowsDirect Communication Function?	105
■ Setting the Function	105
■ Troubleshooting the WindowsDirect Communication Function	110
Connecting to a PC (RS-232C)	111
■ Cable Connection Method	111
■ Data Format	112
■ Command Codes	114
Connecting to a Printer	118
Communication Settings	119
■ Standard Settings (MODE)	120
■ User-Specified Settings	120
Output Timing Change Function	123

11 MAINTENANCE 124

Maintaining the Balance	124
■ Removing the Glass Door	125
Inspection	126
■ Daily Inspections	126
■ Periodic Inspections	127
About Weights	128
■ Types of Weight and Their Selection	128

12 TROUBLESHOOTING 130

What to Do If.....	130
Responding to Messages	131

13 FOR YOUR INFORMATION

132

Turning the Power ON and OFF	132
■ Auto Power-Off Function	132
■ Setting the Startup Display	133
Changing the Password	134
GLP Output Function	135
■ Setting the GLP Output Function	135
■ Setting a Balance ID	137
Specifications	138
■ ATX/ATY Series	138
Maintenance Parts	140
■ ATX/ATY Series	140
Menu Map	143
■ Reading the Menu Map	143
■ Main Menu	144
■ Data Output Menu	145
■ Unit Setting Menu	146
■ Calibration Menu	146
■ Zero / Tare Menu	146

MEMO

BEFORE
WEIGHING

USING THE
BALANCE

USING MORE CONVENIENTLY

MAINTENANCE

TROUBLESHOOTING

FOR YOUR
INFORMATION

1

BEFORE WEIGHING

Name and Function of Components

Main body

The ATX/ATY Series comprises toploading electromagnetic balances with UniBloc weighing mechanism.

Main body

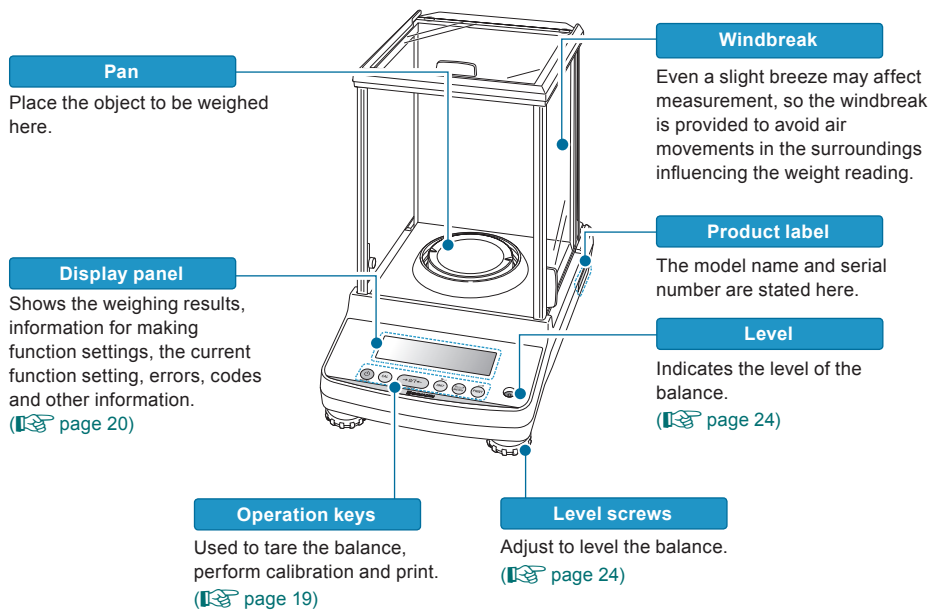

Back of the unit

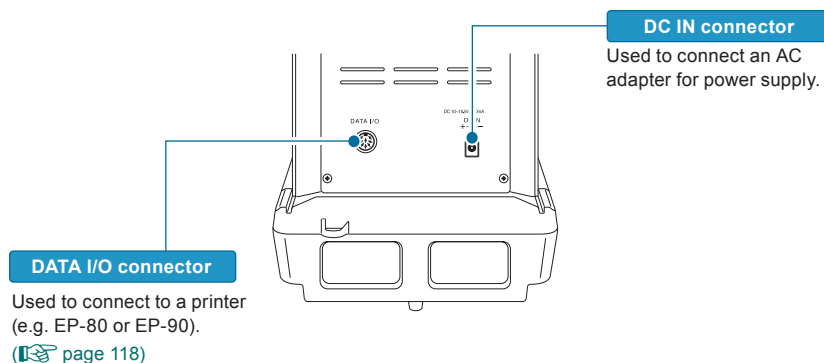

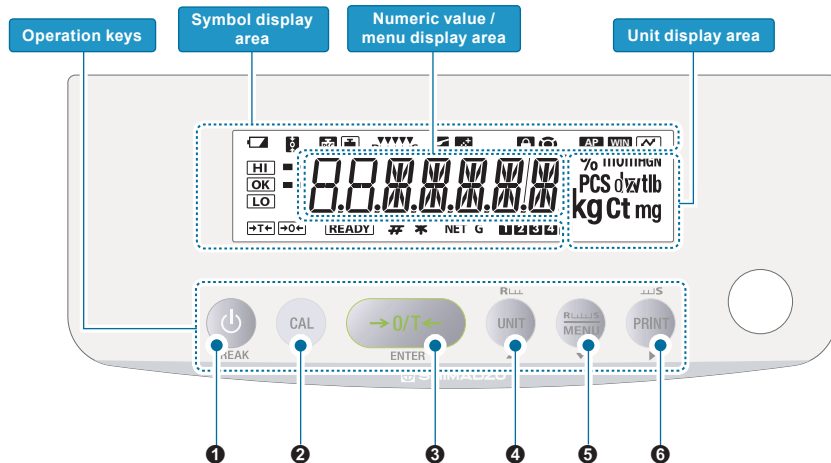

























Operation Keys

No.	Key	During Weighing		During Menu Operation
		Press Once and Release ...	Press and Hold for About 3 Seconds ...	
1	[BREAK]	Switch between the operation and standby modes	-	<ul style="list-style-type: none"> Takes you to a higher level in the menu hierarchy. Long pressing the key quits menu mode and return directly to the weighing mode. Suspends calibration / numerical value entry. Quits the smart setting mode.
2	[CAL]	Performs calibration	Enters the calibration menu	-
3	[O/T]	Tares the balance (setting it to zero)	Opens the zero / tare menu	Confirm and set
4	[UNIT] ▲	<ul style="list-style-type: none"> In the weighing mode: Used to select the unit When piece counting: Displays the unit weight When performing percentage weighing: Displays the reference weight 	<ul style="list-style-type: none"> In the weighing mode: Opens the unit setting menu When piece counting: Used to select the item number When performing percentage weighing: Used to select the percentage reference 	<ul style="list-style-type: none"> Scrolls backward through menu options When entering numerical values: Increases the value In the smart setting mode: Adjusts to response (R) direction.
5	[MENU] ▼	Turns the smart setting mode on	Switches between the weighing mode and the application function mode	<ul style="list-style-type: none"> Scrolls forward through menu options When entering num
6	[PRINT] ►	Outputs the weight reading to a peripheral device (printer or PC)	Opens the data output menu	<ul style="list-style-type: none"> Takes you to a lower level in the menu hierarchy When entering numerical values: Moves the focus one digit on the right In the smart setting mode: Adjusts to Stable (S) direction.

* Refer to P.90 for operations of each key during formulation/operation.

Display Panel

Display	Name	Description	See:
	Battery symbol	Lights up when the battery voltage is low.	-
	Zero tracking symbol	Lit when the zero tracking function is set ON.	Page 63
	Weight symbol	This symbol is lit during calibration. Blinks when calibration is necessary for a verified balance as a legal measuring instrument.	Page 48
	Automatic calibration symbol	Blinks before automatic calibration starts applicable to a verified balance as a legal measuring instrument.	Page 50
	Easy setting indicator	Indicates what level the response and stability are currently set to.	Page 70
	Pouring symbol	Lit when the pouring mode is set.	Page 69
	Formulation symbol	Lit during mixing measurement (formulation) operations.	Page 90
	Menu lock symbol	Lit while the menu is locked.	Page 46
	Menu operation key symbol	Indicates that the menu option currently displayed requires confirm and set operations when  is displayed in the middle. Indicates that a higher or lower level exists in the menu hierarchy when arcs are displayed on the right and left side. Indicates that other menu options can be selected when arcs on the upper and lower side is displayed.	Page 41
	Auto print symbol	Lit when the auto print function is set.	Page 102
	Win symbol	Lit when the WindowsDirect communication function has been set.	Page 106
	Communication symbol	Indicates that data is being exchanged with an external device.	-
	Comparator symbol	When the comparator function (Checkweighing) has been set, indicates the comparison judgment.	Page 96
	Stability mark	Lit when the weight reading is stable. Lit when the option currently set in menu setting is displayed.	Page 42 Page 72
	Minus symbol	Lit when the weight reading is negative.	-
	Ready symbol	Lit during the standby mode. During weighing, lit to indicate the ready to weigh status, for example when using the mixing measurement.	Page 39 Page 90
	Number symbol	Lit when it is possible to enter numerical values.	Page 43
	Hold symbol	Lit when a value that is not the real-time weight reading (for example the indication of the unit weight in piece counting) is displayed.	Page 84 Page 89
	Net weight symbol	Indicates that the weight reading displayed in mixing measurement (formulation) is the net weight of the current component with the weight of the container and prior components. Also indicates that a measuring operation is in progress.	Page 91
	Gross weight symbol	Indicates that the weight reading displayed in mixing measurement (formulation) is the total weight of all of the components of the mixture with the weight of the container subtracted.	Page 91
	Item number indication	Shows the item number in the piece counting mode.	Page 84
	Inverse triangle symbol	When this symbol is lit when changing the position of the decimal point in the conversion factor with the of user-specified units, numerical values can be entered without a decimal point.	Page 44
	Piece counting symbol	Lit while the piece counting mode is in effect.	Page 84

Display	Name	Description	See:
% 0	Specific percentage weighing symbol	Lit when the specific percentage reference has been set for percentage weighing.	Page 96
%	Percentage weighing symbol	Lit during percentage weighing.	Page 99

Numeric value area

Using a verified balance as a legal measuring instrument in the EU:

Model with EC Type Approval. Bracket appears at Scale Interval (d) digit as below.

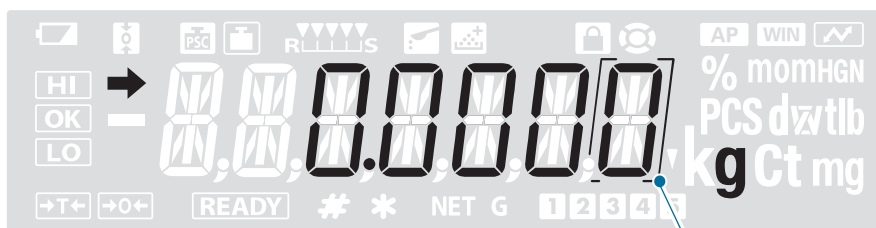

Bracket

Installation

Choosing the Installation Site

The measuring performance of the balance is greatly influenced by the environment where it is installed.

Observe the following points to ensure safe and accurate weighing.

Caution



Prohibitions

Do not use the balance anywhere exposed to explosive, combustible or corrosive gases.

This could cause fire or trouble.



Instructions

Use the correct power supply and voltage with the balance.
Use the balance with the attached AC adapter.

Using an incorrect power supply or voltage with the balance will lead to fire or trouble with the balance.

Note also that if the power supply or voltage is unstable or if the power supply capacity is insufficient, it will not be possible to obtain satisfactory performance from the balance.

Precautions on Use



Prohibitions

Avoid locations where the balance will be exposed to any of the following.

You may not be able to obtain correct weight readings.

- Air flow from an air conditioner, ventilator, door or window
- Extreme temperature changes
- Vibration from surroundings or nearby equipment
- Direct sunlight
- Dust, fine particles, electromagnetic waves or a magnetic field



Instructions

Install the balance on a strong and stable flat table or floor in the room.

Placing the balance in an unstable site could lead to injury or trouble with the balance.

When selecting the installation site, take into account the combined weight of the balance and the item to be weighed.

Unpacking and Delivery Inspection

The items packed will differ depending on the model of balance ordered.

Check that all of the items indicated below are included in the package, and that nothing has been damaged.

The numbers in the boxes [] indicate the quantity of each item.

◆ ATX/ATY Series

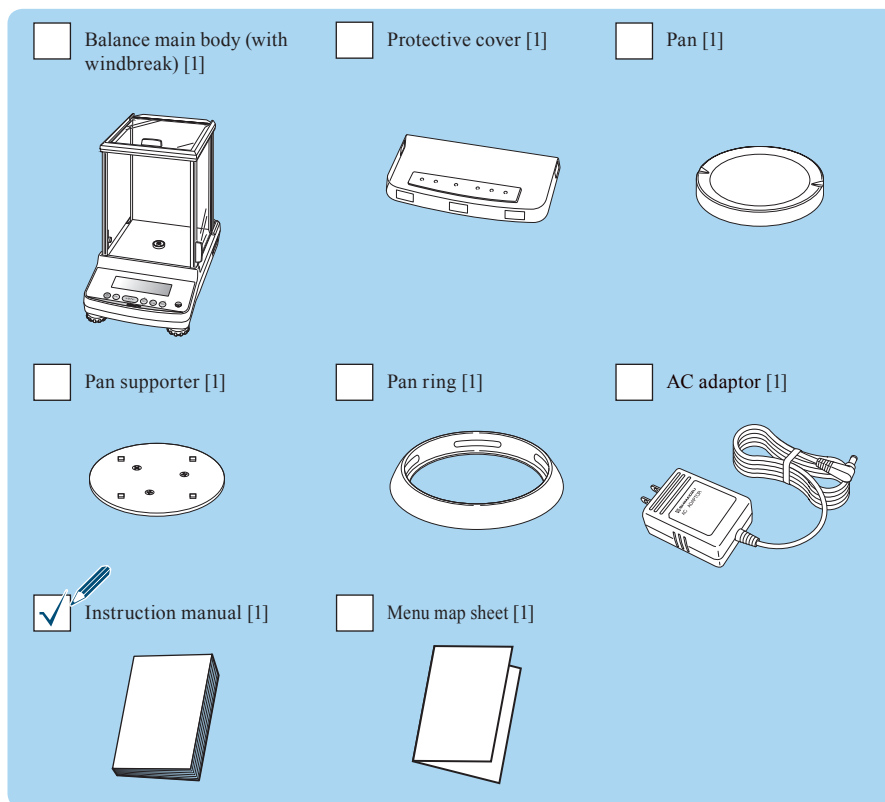

■ Installing the Components

The procedure for fitting the components differs depending on the model of the balance.

◆ ATX/ATY Series

- 1** Place the pan supporter.
- 2** Place the pan on the pan supporters.
Align the two pan notches with the left and right on the balance main body.
- 3** Fit the pan ring.
- 4** Set the protective cover.

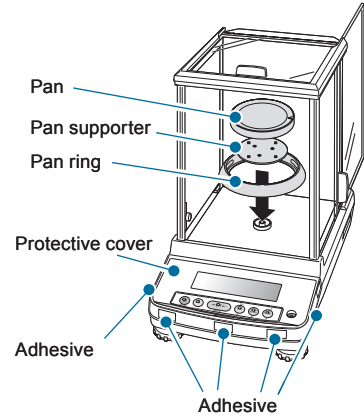

If the balance is used in an environment where it gets dirty easily, use the protective cover available.

- (1) Peel off the paper to expose the adhesive on it.
- (2) Fit it on the display.
- (3) Press the adhesive parts firmly to keep fitting it on the display.

■ Adjusting the Level of the Balance



Operation of the level screws

Turning the level screws clockwise, as viewed from above, extends them and raises the balance, while turning them counterclockwise retracts them and lowers the balance.

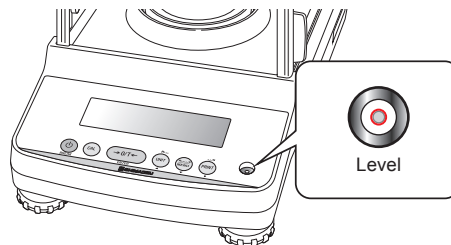



Level the balance by following the procedure below.

- 1** Turn all the level screws (total two at front) counterclockwise as viewed from above until they come to a gentle stop.

The balance will now be tilting toward the front.



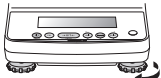

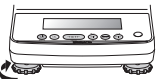
2 Adjust the two level screws at the front so that the air bubble in the level becomes centered in the left/right direction.

At this stage it doesn't matter if the air bubble isn't centered in the front/rear direction.

If the air bubble is left of center 	➔	Turn the front right level screw clockwise. 
If the air bubble is right of center 	➔	Turn the front left level screw clockwise. 

3 Turn both the level screws at the front in the same direction at the same time to center the air bubble in the level in the front/back direction.

Adjust so as to bring the air bubble into the center of the circle.

On turning the two level screws at the front in the clockwise direction... 	➔	The bubble moves toward the front. 
On turning the two level screws at the front in the counterclockwise direction... 	➔	The bubble moves toward the back. 

■ Turning the Power ON

1 Insert the plug of the AC adapter into the DC IN connector on the back of the balance.

2 Connect the AC adapter to the power outlet.

The display will automatically go through the changes indicated below, ending with the OFF display.

The first information displayed is the software version number. Depending on the product, this may differ from the example shown below.

(This is the balance's self check display.)

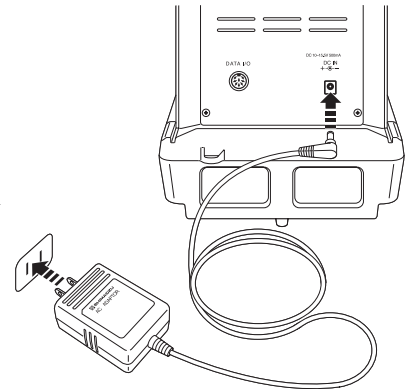

For the ATX series...

An operation check on the internal weight mechanism is performed automatically. During this check, a small motor noise will be heard.



If "ERR H" is displayed...

See "Responding to Messages" (📖 page 131).



Clamps are attached to the AC adaptor.

Fix the cable of the AC adaptor with clamps on an appropriate position on the back of the balance so they do not interfere with the glass door when it is opened or closed.

■ Warming Up

Before performing span calibration on the balance or measuring its accuracy, you must ensure that it is in a stable state.

When stabilizing the balance, it is important that its temperature is stable.

Put the balance in weighing mode (for example showing the gram display) and leave it with the power ON for at least an hour in advance of calibration.

This is called "warming up".

Warming up is also accomplished in the standby mode.

For details on the standby mode, see "Turning the Power OFF" (👉 page 39).

■ Performing Span Calibration

Always perform span calibration for a balance after moving it.

Weights are required for span calibration of the ATX series. For details on weights, see "About Weights" (👉 page 128).

Before performing span calibration, warm up the balance in advance.

Also, carry out the adjustment at a location where there are few people moving around and there is no air flow or vibration.

◆ ATX Series

1 Press

Calibration using the internal weight starts automatically.

 If "WAIT" is displayed...

The calibration record is being output. When output has finished, span calibration will start automatically.

 If "BUSY" is displayed...

There is something placed on the pan. When this item is taken off the pan, span calibration will start automatically. To cancel scan calibration, press 

 If "ERR H" is displayed...

See "Responding to Messages" (👉 page 129).

 If "ERR C" is displayed...

Span calibration was not completed for one of the following reasons.

- ◆ There is too large a discrepancy between the zero point of the balance and the sensitivity.
- ◆ A container has been placed on the pan.
- ◆ The pan is not on the balance.
- ◆ There is too large a discrepancy in the value of the internal weight.

Press  and redo the operation from the beginning. If even on doing this the same display reappears, calibrate the internal weight (👉 page 56).



* This may not be displayed.



"END" will be displayed and the balance will return to the weighing mode.

⚠ Caution



Instructions

If calibration doesn't end normally and the balance stops, do not move it nor leave it as it is.

Moving the balance in such a condition may cause failure because the internal weight is not held correctly.

Before moving the balance, be sure to turn the power on and start it up correctly (so that the internal weight is correctly held).

◆ ATY Series

1

Press 

The weight value will flash.



If "WAIT" is displayed...

The calibration record is being output. When output has finished, span calibration will start automatically.



If "BUSY" is displayed...

There is something placed on the pan. Take the item off the pan and follow the procedure below.

To cancel scan calibration, press  .



If no operation is performed within 60 seconds...

"ERR C" (calibration error) is displayed.

Press  and repeat the operation from the beginning.



2 Enter the weight value.

If necessary, change the weight value to match the weight that will be used for calibration. If there is no need to change it, proceed to step 3.

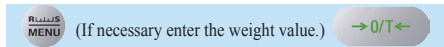

"Entering Numerical Values", page 43

For details on the weight values that can be entered, see "Specifications" (page 138).



3 Place the calibration weight on the pan.

Open the glass door in the windbreak, place the weight on the pan, and shut the glass door again. Wait until the flashing weight value display changes to a flashing zero.



Shut the glass door fully.

After placing a weight on the pan or removing a weight from the pan, check that the glass door is fully shut.

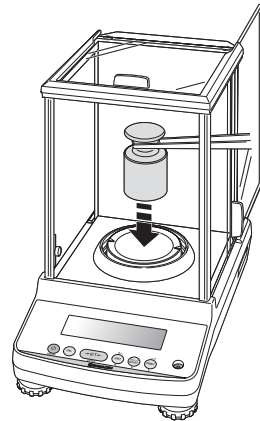

4

Take the calibration weight off the pan.

Open the glass door in the windbreak, remove the weight from the pan and shut the glass door again.

"END" will be displayed and the balance will return to the weighing mode.

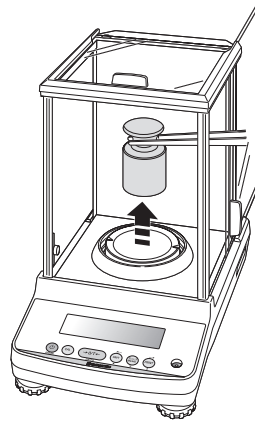

The procedure described above is the default standard span calibration procedure. For details, see "4. CALIBRATION" (👉 page 48).

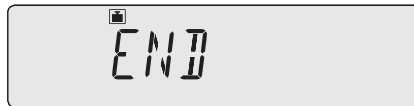

2 USING THE BALANCE

Weighing

1 Enter the weighing mode.



What is the weighing mode?

The balance is in the state where it indicates the units (for example grams) of the weight on the pan.

To establish the weighing mode, follow the steps below depending on the current status of the balance.

Status of the Balance	To Establish the Weighing Mode....
The display is off.	Press . When the "OFF" indication appears or all segments are lit, press any key.
"OFF" indication, all segments lit, or READY (ready symbol) lit	Press any key.
The application function mode is established.	Press for about 3 seconds.
A menu indication is displayed.	Press a number of times. Or press for about 3 seconds.
The balance is accepting numerical value entry.	Press a number of times.



If an indication like "OL" or "-OL" appears during measurement...

See "Responding to Messages" (page 131).

With models that feature the windbreak

2 Place a container on the pan.

Open the glass door in the windbreak, place the container on the pan and shut the glass door again.

3 Once the display has stabilized (has lit), press

The indication changes to zero.

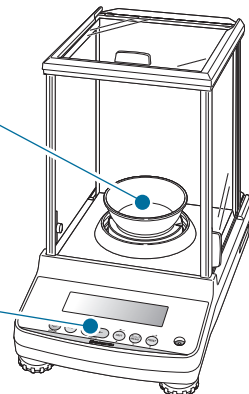

4 Insert the sample (item to be measured) into the container.

Open the glass door of the windbreak, place the sample (item to be weighed) on the pan and shut the glass door again.

5 When the display has stabilized, → (the stability mark) lights up, read the display.

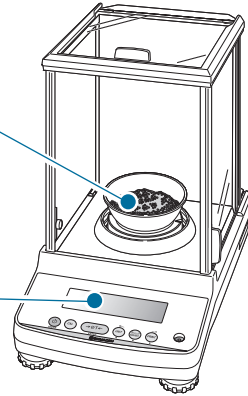

Shut the glass door fully.

Check that the glass door is fully shut before reading the balance display.



Avoid doing the following:

- ◆ Putting your hand inside the glass door of the windbreak
- ◆ Touching the container or sample with bare hands
- ◆ Weighing samples (items to be weighed) of different temperatures

The heat will lead to convection, and this may make the balance display unstable. Use forceps or gloves to carry containers and samples.

When dealing with samples (items to be weighed) at different temperatures, eliminate the temperature difference by leaving the samples around the pan inside the glass door before weighing.

Outputting Weight Readings

When the balance is connected to a PC and a printer (option), you can output a weight reading, settings, and so on for each measurement. The WindowsDirect communication function (👉 page 105) is convenient for output to a PC.

- When the GLP output function (👉 page 135) is set to OFF, only the weight reading is output.
- When the GLP output function (👉 page 135) is set to ON, the following information is output.

Example printout from printer
(When the GLP output function is set to ON)

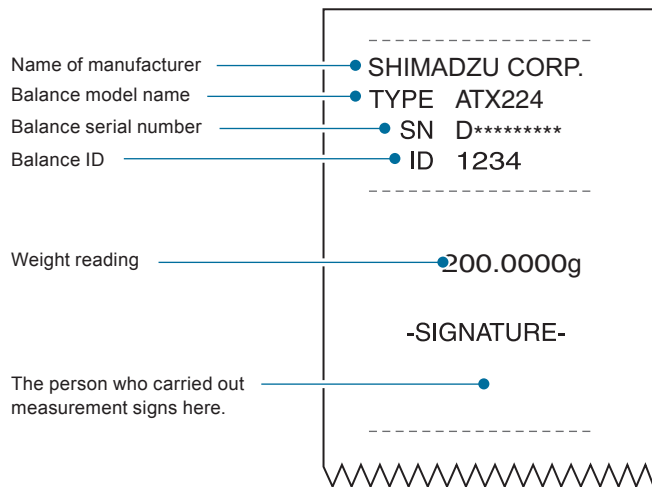

Selecting the Display

Switching Units

You can display different units from among those set to be available.

1 Press in the weighing mode.

Repeatedly pressing this key will cycle you through the registered units.

When the balance is shipped from the factory, the only unit registered is grams.

To be able to switch to other units, you must first register the units you wish to use.

 "Selecting Units to Display", page 77

When user-specified units have been selected, the characters and symbols that indicate the units don't light up.

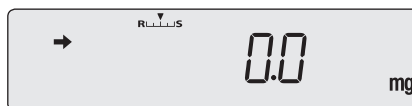
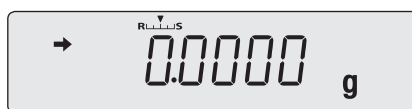

Unit display after restarting

When the power is turned off and back on, the balance starts up displaying the units that were in use before the power was turned off.

Selecting the Minimum Number of Displayed Digit (1d/10d display)

If necessary, the minimum number of displayed digit can be reduced by one digit (Set to the 10d display).



Not applicable to a verified balance as a legal measuring instrument.

1 Press twice shortly in the weighing mode.

This opens the main menu.



* This may not be displayed.

▽ Selecting the Display

2 Select the measurement parameters in other functions.

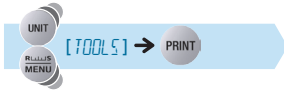

3 Select switching between 1D and 10D, and confirm at 10D.

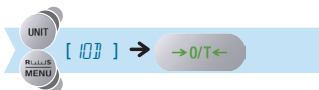

4 Return to the weighing mode.



Display after selection

The decimal place doesn't change. Note also that when one digit is removed the display area for the final digit appears as a blank.



To return to the 1d display...

Follow the above steps, and confirm on the 10D display in step 4.

Selecting the Decimal Point Display Symbol

The decimal point can be displayed as either "." (a period) or "," (a comma).

1 Press **UNIT** **MENU** twice shortly in the weighing mode.

This opens the main menu.



* This may not be displayed.

2 Select decimal point display setting.

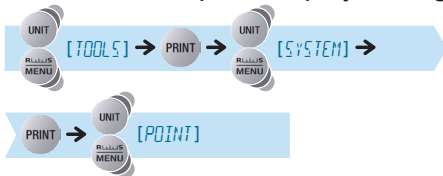

3 Select the decimal point display symbol.

To select "." (period):



To select "," (comma):

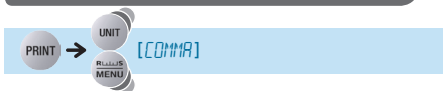

When outputting to the ER-50/EP-60A electronic printer (old type)...

Do not select "," (comma). The printer may not print it correctly.

▽ Ending Weighing

4 Confirm and return to the weighing mode.



The way the decimal is displayed has now changed.



Selecting the decimal point display symbol

When the decimal point display is changed, the decimal point changes accordingly in data output to external devices such as printers.



- To select the period



- To select the comma



Ending Weighing

Turning the Power OFF

1 Establish the weighing mode.

 "Weighing", page 32

2 Press 

If the status described below is not established, press  again.

READY (the ready symbol) will light and the standby mode will be established.

Normally, leave the balance on standby in this state until the next weighing.

To shut the power off completely, disconnect the AC adaptor.

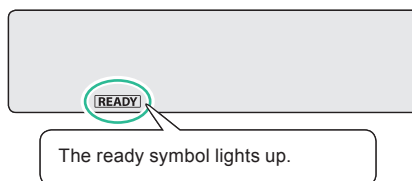

? What is the standby mode?

This is the status in which the balance stands by, saving electricity although it can still be used right away.

On pressing  in the weighing mode the display is turned off, **READY** (the ready symbol) is lit and the power saving status (standby mode) is established.

During the standby mode, the interior of the balance is powered and in the warming-up status, ready for immediate use.

Caution



Prohibitions

While [WAIT] or [SET] is displayed, on no account disconnect the AC adaptor.

There is a risk that data in the scale will be corrupted.

3 MENU SETTINGS

What Is the Menu?

With the ATX/ATY series, the menu is used to efficiently select the right functions for the user's application.

The Structure of the Menu

The menu is divided into five groups according to the setting made.

Menu Group	Description
Main menu	Used to set the application function mode, comparator, stability/response adjustment and system configuration
Calibration menu	Used to set the details for calibration
Zero / tare menu	Used to set the details for taring and zero point
Data output menu	Used to set the functions for transmitting data to a PC or outputting them to a printer
Unit setting menu	Used to set which units may be displayed in weighing mode

You can open each menu group by pressing the various operation keys.

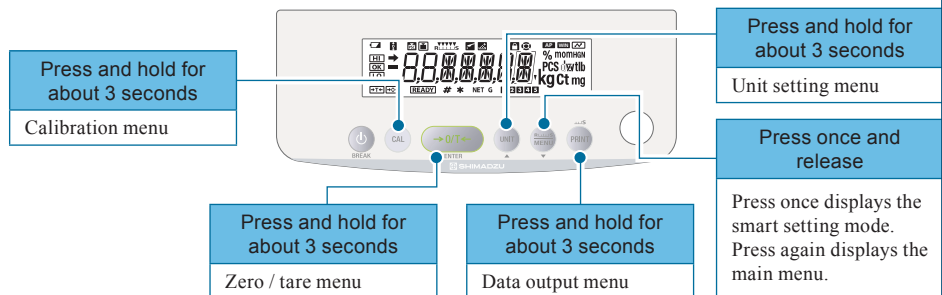

Within each menu group are a number of hierarchical menu levels.

You can move between levels in the menu hierarchy by pressing and .

You can scroll through the options within each level of the hierarchy by pressing or .

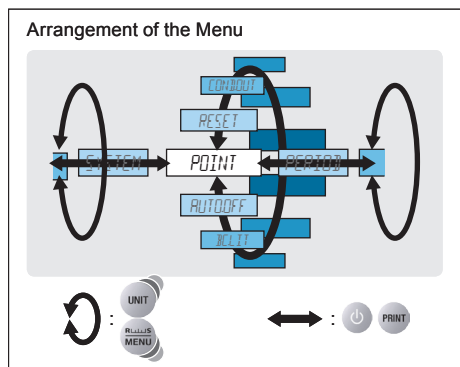

Menu Map

The menu map represents the organization of the menu options graphically to make it easy to understand.

It is useful for quickly accessing the menu option you want to use.

For more on the menu map, see "Menu Map" (📖 page 143) and "Menu Map Sheet".

Instruction Manual

The instruction manual describes specific parts of the menu operations in a simplified form.

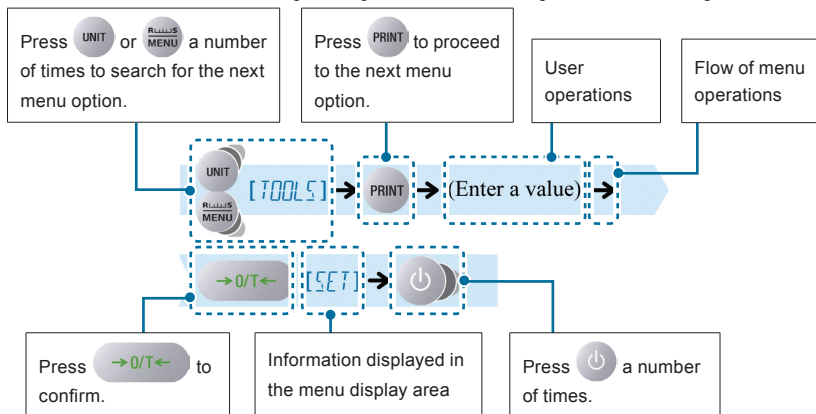

Menu Operation Key Symbol

On entering menu operation, **⦿** (the menu operation key mark) lights up.

The keys represented by lid segments can be used.

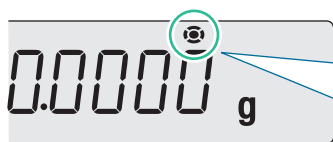

Example of numeric value entry

Displayed symbol	Meaning
⦿ in the middle	The menu option currently displayed requires confirm and set operations
Arcs on the right and left side	A higher or lower level exists in the menu hierarchy
Arcs on the upper and lower side	Other menu options can be selected

Basic Menu Operations

1 Open the target menu from the weighing mode.

The method used to open a menu option differs depending on the group.

For details on the methods used for menu opening from each group, see "The Structure of the Menu" (📖 page 40).



For a menu option that is already set...

➔ (the stability mark) appears in the menu display.

2 Confirm and return to the weighing mode.

The operation after confirming the menu selection differs depending on the menu, and you will either be returned to the weighing mode automatically or will need to do it manually.

To return to the weighing mode manually, press  a number of times or press  for about 3 seconds.



If you open the menu again...





The recently set menu option will be displayed first.

Note also that, when the set menu option is displayed, ➔ (the stability mark) also appears.

Entering Numerical Values

Numerical values sometimes have to be entered for menu settings, for example the weight value of a calibration weight, condition values for operating functions, the balance ID, passwords, etc.

◆ Operations of the operation keys

Operation Key	Operation During Numerical Value Entry
	Confirms the entered numerical value
	Increases the value of the digit to be entered (the flashing digit) Pressing this key while the decimal point is flashing shifts the decimal point to the left.
	Decreases the value of the digit to be entered (the flashing digit) Pressing this key while the decimal point is flashing shifts the decimal point to the right.
	Shifts the digit to be entered (the flashing digit) one digit to the right
	Cancels entry

■ Changing the Numerical Value

As an example, here is the procedure for changing "120.0000 g" to "200.0000 g".

1 Enter the numeric value entry mode.

(the number symbol) lights and the leftmost digit (highest digit) in the range where the value can be changed flashes.



2 Press  once.

The numerical value of the flashing digit increases by one, so that it changes from "1" to "2".



3 Press . The flashing shifts to the second digit from the left.



▽ Entering Numerical Values

- 4** Press  twice.
The numerical value of the second digit from the left decreases two times, so that it changes from "2" to "1" to "0".



- 5** Press 
This confirms the entered numerical value. The indication shown to the right remains displayed for several seconds, then the display automatically moves on to the next step.



■ Changing the Position of the Decimal Point

The position of the decimal point can only be changed when entering a conversion factor with the user-specified units.

 "Conversion Factors", page 78



As an example, here is the procedure for shifting the position of the decimal point one digit to the left, to change the displayed value from "100.000" to "10.0000".

- 1** Establish the numeric value entry mode.
(the number symbol) lights and the leftmost digit (highest digit) in the range where entry (change) is possible flashes.



- 2** Press  several times until the decimal point flashes.



- 3** Press  or  several times.
This will move the decimal point to the left or right.



To set a numerical value with no decimal point...

Press  several times until ▼ (the inverse triangle symbol) flashes.

- 4** Press 
This confirms the entered numerical value. The indication shown to the right remains displayed for several seconds, then the display automatically moves on to the next step.



Convenient Functions for Menu Setting

Returning to the Default Settings (Menu Reset)

If you want to return the menu settings to the default settings, reset the menu.

The default settings are indicated by asterisks in the menu map (👉 page 144) and on the menu map sheet.

- 1** Press  twice shortly in the weighing mode.

This opens the main menu.

STAND[®]

- 2** Select menu reset.

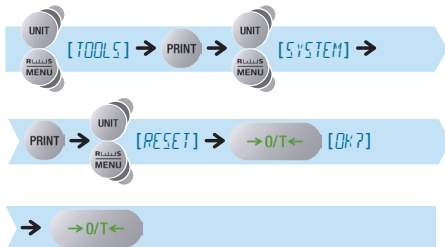

RESET[®]

OK?[®]

- 3** Enter the password.

The password is set to "9999" before shipment. If the default setting is not changed, enter "9999".

👉 "Entering Numerical Values", page 43

👉 "Changing the Password", page 134

P-0000[®]

- 4** Confirm.



WAIT

SET

The default menu settings are reinstated and the balance automatically returns to weighing mode.

Prohibiting Changes to the Menu Settings (Menu Lock)

In order to ensure that the menu settings are not changed by mistake, the person managing the balance controls the password and can prohibit menu operation.

The default password is "9999". To change the password, see "Changing the Password" (👉 page 134).



Operation in the menu lock status

Even when the menu is locked it is possible to perform calibration (CAL) and change the weight value.

1 Press  **3** /sec. until the display changes (about three seconds) while "OFF" is displayed after supplying power or while in the standby mode.

- OFF display after supplying power



- Standby mode



2 Enter the password.

👉 "Entering Numerical Values", page 43



3 Press 

The password will be accepted.
The menu will be locked and the display will return to the indication in step **1**.



The menu lock symbol will light up.

If the password is wrong...

The error message shown to the right will be displayed and the display will return to the indication in step **1**.



4 Confirm.

On entering the weighing mode...

 (the menu lock symbol) is shown in the display.



On performing prohibited operations...

"LOCKED" is displayed and menu operation is not possible.





Releasing the menu lock

To release the menu lock, perform steps **1** through **3** again.

Outputting the Menu Setting Information

You can output the menu settings to make a record of the balance settings.

1 Connect the balance to a PC or printer (option).

"10. CONNECTION AND COMMUNICATION WITH PERIPHERAL DEVICES", page 100

2 Press twice shortly in the weighing mode.

This opens the main menu.



3 Select output of menu setting information

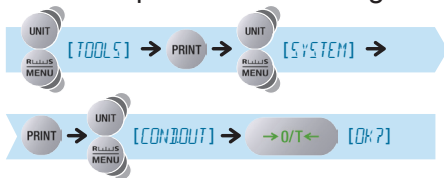

To output the settings, proceed to step **4**.

To cancel, press and return to the weighing mode.

4 Confirm.



During output the communication symbol is lit.

On confirmation, the menu setting information is output to the PC or printer.

The balance automatically returns to weighing mode.

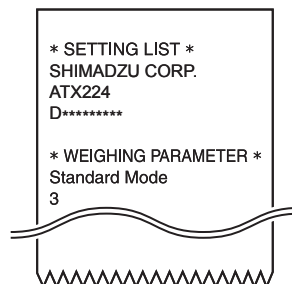

4 CALIBRATION

In order to weigh accurately with an electronic balance, the balance must be calibrated after it has been moved or if the room temperature has changed substantially.

You are also advised to carry out calibration routinely (before use every day).

Before Starting Calibration...

Following calibration operations are possible with the ATX/ATY series.

Span calibration

Adjust to achieve correct balance sensitivity using either the internal weight (ATX only) or the external weight. Drift in the sensitivity is corrected.

Registering the internal weight (ATX only) or the external weight on **CAL**, you can start operations only by pressing **CAL**.



The operation to calibrate the internal weight itself cannot be registered in **CAL**.

To calibrate the internal weight itself, refer to "Calibration of the Internal Weight (ATX Only)" (📖 page 56).

Use the following procedure to set the preferred operation for **CAL**.

1 Press **CAL** for about 3 seconds.

This opens the calibration menu.

2 Select either "internal weight" or "external weight".

Example of registering "span calibration using the internal weight"

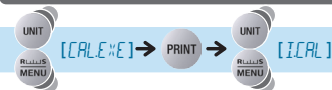

Example of registering "span calibration using the external weight"

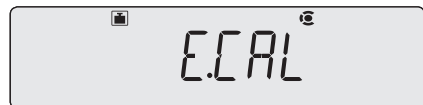

3

Confirm and return to the weighing mode.



Whichever was selected in step 2 is set for **CAL** and the balance returns to the weighing mode.



- When "span calibration using the external weight" has been selected



When executing "span calibration", see "Span Calibration and Adjustment" (👉 page 52).

Automatic calibration (ATX only)

 Applicable to a verified balance as a legal measuring instrument.

Calibration with internal weight executes automatically in weighing mode under any of the following circumstances.

- (1) When there is a change in the surrounding temperature.
- (2) When about four hours has passed since the previous calibration.
- (3) After either condition (1) or (2) above has been met during warm up at stand-by status, when the balance is switched to mass display mode.

⇒ When there is a change in the surrounding temperature or about four hours has passed since the previous span adjustment, the indicator  will blink.

When two minutes pass since  blinking start,



Case1) There is no load on the pan.

"PSC.RUN" is displayed and automatic span adjustment is executed.
It returns to the weighing mode when automatic span adjustment ends.





Case 2) There is some load on the pan.

Mass display will blink.



When two minutes pass since mass display blinking start, "PLS.CAL" is displayed.
If "PLS.CAL" is displayed, please unload the thing on the pan and execute span adjustment.



 Push  key when you must keep measuring after "PLS.CAL" is displayed. Return to blinking mass display.

If the span adjustment is not executed, the mass display blinking for two minutes and "PLS.CAL" display are repeated.

Announcement of calibration request (ATY only)



Applicable to a verified balance as a legal measuring instrument.

- (1) When there is a change in the surrounding temperature.
- (2) When about four hours has passed since the previous calibration.
- (3) After either condition (1) or (2) above has been met during warm up at stand-by status, when the balance is switched to mass display mode.

⇒ When there is a change in the surrounding temperature or about four hours has passed since the previous span adjustment, the indicator  will blink.

When two minutes pass since  blinking start,



Case1) There is no load on the pan.

"PLS.CAL" is displayed.

It returns to the weighing mode when calibration with external weight ends.



Case 2) There is some load on the pan.

Mass display will blink.



When two minutes pass since mass display blinking start, "PLS.CAL" is displayed.

If "PLS.CAL" is displayed, please unload the thing on the pan and execute span adjustment.



Push  key when you must keep measuring after "PLS.CAL" is displayed. Return to blinking mass display.

If the span adjustment is not executed, the mass display blinking for two minutes and "PLS.CAL" display are repeated.

Span Calibration and Adjustment

Adjust to achieve correct balance sensitivity using either the internal weight (ATX only) or the external weight.

Set the relevant "span calibration" in **CAL** in advance by following the procedure in "Before Starting Calibration ..." (👉 page 48). (As the default setting, "span calibration using the internal weight" is set for ATX, and "span calibration using the external weight" is set for ATY.)

◆ Span calibration using the internal weight (ATX series only) **I.CAL**

1 Press **CAL**

When the GLP output function (👉 page 135) has been set to ON, initially the indication "WAIT" is displayed, then the balance model name and other information is output.

After a little while  (the weight symbol) lights up and span calibration using the internal weight will start automatically.



If "WAIT" is displayed...

The calibration record is being output. When output has finished, span calibration will start automatically.



If "BUSY" is displayed...

There is something placed on the pan. When this item is taken off the pan, the span calibration will start automatically. To cancel the span calibration, press .



If "ERR H" is displayed...

See "Responding to Messages" (👉 page 131).



* This may not be displayed.







If "ERR C" is displayed...

Span calibration was not completed for one of the following reasons.

- ◆ There is too large a discrepancy between the zero point of the balance and the sensitivity.
- ◆ A container has been placed on the pan.
- ◆ The pan is not on the balance.
- ◆ There is too large a discrepancy in the value of the internal weight.

Press  and redo the operation from the beginning. If even on doing this the same display reappears, calibrate the internal weight ( page 56).

"END" will be displayed and the balance will return to the weighing mode.



Caution



Instructions

If calibration doesn't end normally and the balance stops, do not move it nor leave it as it is.

Moving the balance in such a condition may cause failure because the internal weight is not held correctly.

Before moving the balance, be sure to turn the power on and start it up correctly (so that the internal weight is correctly held).

◆ Span calibration using the external weight **E.CAL**

1 Press in the weighing mode.

When the GLP output function ( page 135) has been set to ON, initially the indication "WAIT" is displayed, then the balance model name and other information is output.

After a little while  (the weight symbol) lights up and the weight value of the weight to be placed on the pan flashes.



If "WAIT" is displayed...

The calibration record is being output. When output has finished, span calibration will start automatically.



If "BUSY" is displayed...

There is something placed on the pan. Take the item off the pan and follow the procedure below.

To cancel scan calibration, press .



If no operation is performed within 60 seconds...

"ERR C" (calibration error) is displayed.

Press  and repeat the operation from the beginning.

2 Enter the calibration weight value.

If necessary change the weight value displayed to match the weight that will be used for calibration. If there is no need to change it, proceed to step 3.

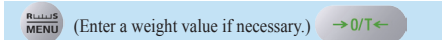

 "Entering Numerical Values", page 43

For details on the range of weight values that can be used, see "Specifications" ( page 138).



3 Place the weight on the pan.

Open the glass door in the windbreak, place the weight on the pan, and shut the glass door again. Wait until the flashing weight value display changes to a flashing zero.



Shut the glass door fully.

After placing a weight on the pan or removing a weight from the pan, check that the glass door is fully shut.

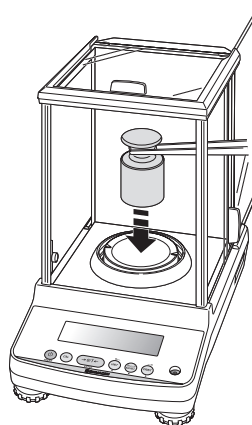

4 Take the calibration weight off the pan.

Open the glass door in the windbreak, remove the weight from the pan and shut the glass door again.

"END" will be displayed and the balance will return to the weighing mode.

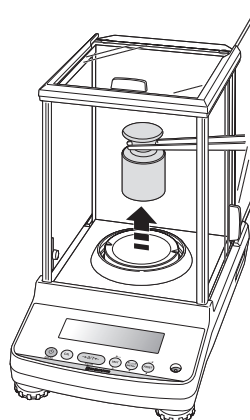

Avoid doing the following:

- ◆ Putting your hand inside the glass door of the windbreak
- ◆ Touching the container or sample with bare hands
- ◆ Weighing samples (items to be weighed) of different temperatures

The heat will lead to convection, and this may make the balance display unstable.

You are recommended to use forceps or gloves to carry containers and samples.

When dealing with samples (items to be weighed) at different temperatures, eliminate the temperature difference by leaving the samples around the pan inside the glass door before weighing.

Calibration of the Internal Weight (ATX Only)

In the ATX series, the weight for calibration is built in. The internal weight itself is calibrated on shipment from the factory, but it is possible to recalibrate it using external weights. This is called

P.CAL

For the range of values for the external weights that can be used, refer to "Specifications" (👉 page 138).

💡 Not applicable to a verified balance as a legal measuring instrument.

1 Press  for about 3 seconds.
 This opens the calibration menu.

2 Select calibration of the internal weight.



3 Enter the administrator's password.

- 👉 "Entering Numerical Values", page 43
- 👉 "Changing the Password", page 134



4 Press .
 The password is acknowledged and the external weight value for calibration flashes.



💡 If "WAIT" is displayed...
 The calibration record is being output. When output has finished, span calibration will start automatically.



If the password is wrong...
 The error message shown to the right will be displayed and the display will return to the indication in step **1**.



5 If necessary, enter a weight value.

If no change is to be made, proceed to step 6 without doing anything.

0/T (If necessary, enter a weight value.) 0/T

"Entering Numerical Values", page 43

For the range of weight values that can be used, refer to "Specifications" (page 138).

6 Place the weight on the pan.

Wait until the flashing weight value indication changes to a flashing zero indication.



If "ERR C" is displayed...

The internal weight has not been calibrated for one of the following reasons.

- ◆ The wrong weight has been placed on the pan.
- ◆ No operation has been performed within 60 seconds of the flashing weight value or zero display.

Press and repeat the operation from the beginning.



BEFORE
WEIGHING

USING THE
BALANCE

USING MORE CONVENIENTLY

MAINTENANCE

TROUBLESHOOTING

FOR YOUR
INFORMATION

▽ Calibration of the Internal Weight (ATX Only)

7 Take the calibration weight off the pan.

Open the glass door of the windbreak, take the weight off the pan, and close the glass door.

 If "BUSY" is displayed...

There is something placed on the pan. When this item is taken off the pan, internal weight calibration will start automatically.

To cancel internal weight calibration, press 

 If "ERR H" is displayed...

See "Responding to Messages" ( page 131).

 If "ERR C" is displayed...

The internal weight has not been calibrated for one of the following reasons.

- ◆ There is too large a discrepancy between the zero point of the balance and the sensitivity.
- ◆ A container has been placed on the pan.
- ◆ The pan is not on the balance.
- ◆ There is too large a discrepancy in the value of the internal weight.

Press  and repeat the operation from the beginning.



CAL3 ~ CAL0 are performed.



* This may not be displayed.



"END" is displayed, then span calibration using the internal weight starts.

When span calibration using the internal weight ends, the balance returns to the weighing mode.

 "Span Calibration and Adjustment" page 52

Caution



If calibration doesn't end normally and the balance stops, do not move it nor leave it as it is.

Instructions

Moving the balance in such a condition may cause failure because the internal weight is not held correctly.

Before moving the balance, be sure to turn the power on and start it up correctly (so that the internal weight is correctly held).

Leaving a Record of Calibration

You can leave a record of execution of calibration and set an ID for a balance to facilitate management of multiple balances.

Example Printout of a Calibration Record

You can output a record of execution of calibration to a PC or printer (option).

The WindowsDirect communication function (👉 page 105) is useful for output to a PC.

The output calibration record includes the following items.

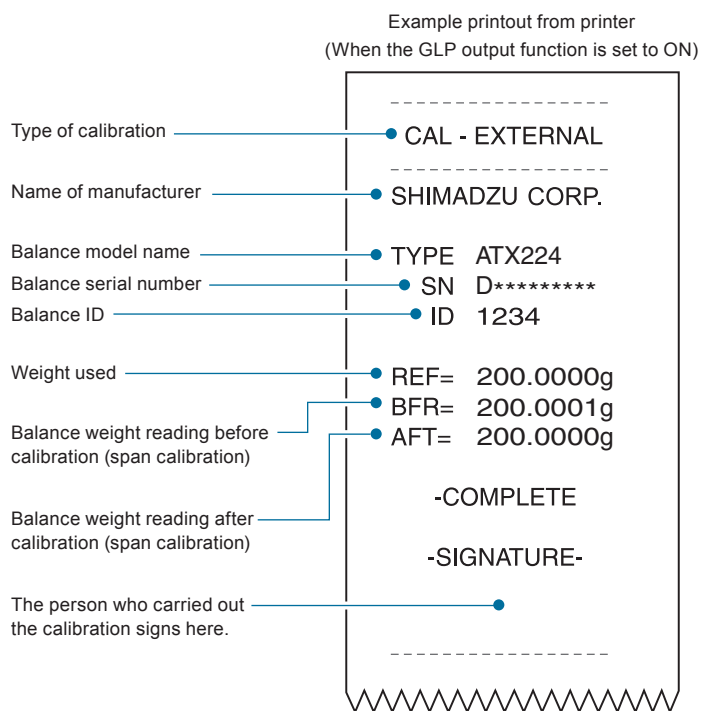

Outputting the date and time

Since the ATX/ATY series doesn't incorporate a clock function, it is not possible to output the date and time from the balance.

■ Setting Output of a Calibration Record

Output of the calibration record can be set by turning the GLP output function (👉 page 135) ON and OFF.

When the GLP output function is set to on, the statistic calculation function of the printer cannot be used.

1 Press   for about 3 seconds.
This opens the calibration menu.

2 Select the GLP output function.

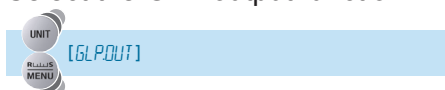

Stability Mark	GLP Output Function
Lit	ON
Unlit	OFF

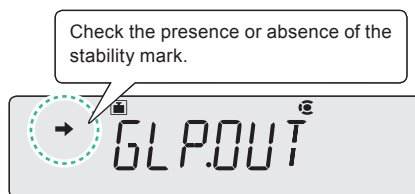

3 Change the setting.

Pressing  alternately sets the ON and OFF settings.

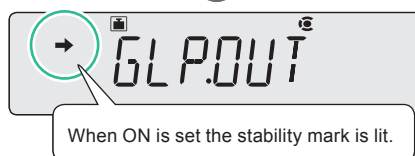
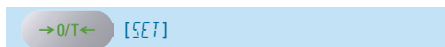

4 Return to the weighing mode.



■ Setting a Balance ID

When managing multiple balances, you can set a four-digit management number (ID) for each balance which will be indicated as part of calibration records output.

- 1 Press  twice in the weighing mode.

This opens the main menu.

- 2 Select setting of a balance ID.

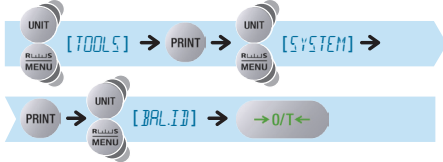

- 3 Enter the required numerals (max. 4 digits).

(Enter the ID.) →  [SET]

 "Entering Numerical Values", page 43

The default ID is "0000".



- 4 Return to the weighing mode.

 or  3 sec.

5

FUNCTIONS RELATING TO TARING

The ATX/ATY series has the following functions relating to the zero point and taring. Make use of these functions in accordance with the weighing environment and the application.

Zero / Taring Functions

Zero tracking function

Fluctuations in the zero point that occur immediately after turning the power ON and as a result of temperature changes are compensated for, so the zero indication is maintained.

 page 63

Auto zero function

Drift of the zero point that occurs as a result of material left on the pan after measurement is automatically compensated for.

See Hint  as blow.

 page 64

Auto tare function

After outputting a weight reading, taring is executed automatically.

 page 66

Zero / tare timing change function

After waiting for  (the stability mark) to light up, zero point setting / taring is executed.

See Hint  as blow.

 page 67



What is taring?

This is a function whereby the weight of the container placed on the pan is subtracted to set the display to zero, so that only the weight of the sample placed inside the container is indicated.



What is the zero point?

This means the state where nothing is placed on the pan, zero is indicated, and weighing can be started.



Not applicable to a verified balance as a legal measuring instrument.

Zero Tracking Function

When the zero tracking function is set, when the indication is zero (including when taring is performed) the fluctuations in the zero point that occur immediately after turning the power ON and due to temperature changes and other factors are compensated for and the zero indication is maintained. (In the default setting the zero tracking function is ON.)

- 1 Check  (the zero tracking symbol) in the weighing mode.

Zero Tracking Symbol	Zero Tracking Function
Lit	ON
Unlit	OFF

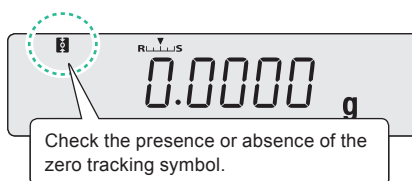

If you proceed to the next step while zero tracking is ON, it goes OFF.

- 2 Press  twice.

This opens the main menu.

 Setting from the zero / taring menu

You can also press  for about 3 seconds and make the setting from the zero / taring menu.

- 3 Select the zero tracking function.

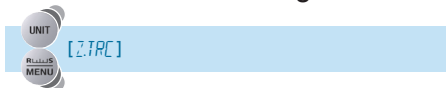

- 4 Confirm the ON or OFF selection.

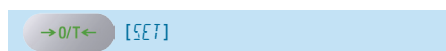

The ON or OFF status will be selected and the balance will automatically return to the weighing mode.

After setting "ON",  (the zero tracking symbol) lights up.

When the setting has been made from the zero / taring menu





When the zero tracking function is ON, the stability mark is lit in the menu display.

Auto Zero Function

When the auto zero function is set, any drift of the zero point that occurs as a result of material left on the pan after weighing is automatically compensated for so that zero is displayed.

Note that the auto zero function cannot be used in combination with formulation.

 Not applicable to a verified balance as a legal measuring instrument.

1 Press  for about 3 seconds in the weighing mode.

This opens the zero / taring menu.

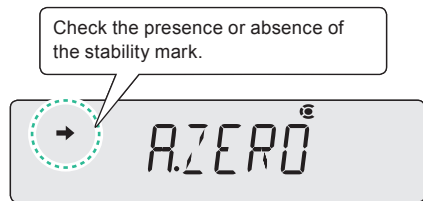
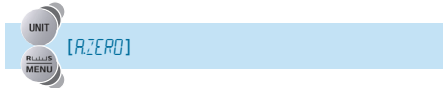

2 Select the auto zero function.



What is the current situation?

Stability Mark	Auto Zero Function
Lit	ID is ON
Unlit	ID is OFF

What do you want to do?

To set or Update...	To Cancel...
Press  and go to step 3.	Press  and go to step 4.
Press  and go to step 3.	Go to step 4.

3 Enter the value for the range for automatic compensation to the zero point (auto zero range).

(Enter the zero range value.) →  [SET]

 "Entering Numerical Values", page 43

If there is anything with a weight lower than or equal to the auto zero range value left on the pan after weighing the sample, it will automatically be compensated for and the zero point will be established when  (the stability mark) lights up.





Auto zero range value

The auto zero range value is only effective in the units that are displayed when the value is entered.

If other units are later selected, change (update) the setting for the zero range value by following the procedure from step 1 while these new units are displayed.

The upper limit value for the zero range is 99 d. 1 d is the minimum indication in the displayed units.

For example, for a balance with a minimum indication of 0.0001 g, the situation is as follows.

Units	Minimum Indication	Upper Limit Value for the Zero Range
g	0.0001 g	0.0099 g
ct	0.001 ct	0.099 ct

4

Return to the weighing mode.



Auto Tare Function

When the auto tare function is set, the balance is automatically tared after the weight reading has been output, and the indication at that point is set to zero.

- 1** Press  for about 3 seconds in the weighing mode.

This opens the zero / taring menu.

- 2** Select the auto tare function.

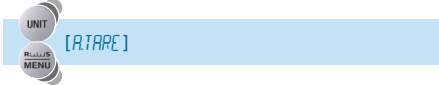

Stability Mark	Auto Tare Function
Lit	ON
Unlit	OFF

- 3** Change the setting.

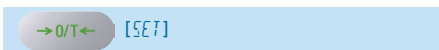

Pressing  alternately sets the ON and OFF settings.

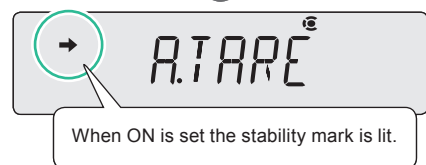
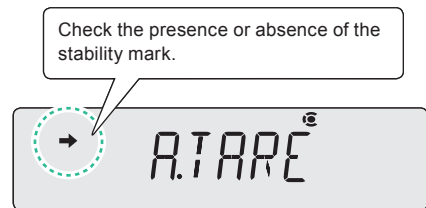

- 4** Return to the weighing mode.



Zero / Tare Timing Change Function

The zero / tare timing change function allows you to select whether setting of the zero point / taring is executed without waiting for  (the stability mark) to light up, or after waiting for  (the stability mark) to light up after pressing .

This function can also be applied to operations under the auto zero function and the auto tare function. (The default setting is for execution without waiting for  (the stability mark) to light up.)



Not applicable to a verified balance as a legal measuring instrument.

- 1 Press  for about 3 seconds in the weighing mode.

This opens the zero / taring menu.

- 2 Select the zero / tare timing change function.



Stability Mark	Zero / Tare Timing Change Function
Lit	The balance doesn't wait for stability
Unlit	The balance waits for stability.

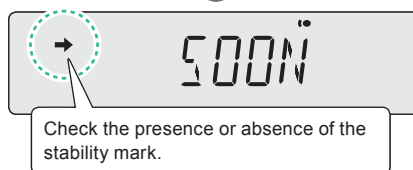

- 3 Change the setting.

Pressing  alternately selects the "wait for stability" and "don't wait for stability" settings.

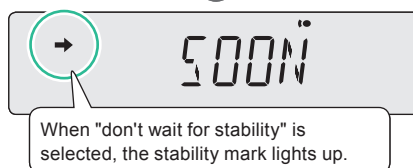
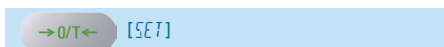

- 4 Return to the weighing mode.



6

ADJUSTING RESPONSE AND STABILITY

The response and stability of the balance can be adjusted in several ways in accordance with the installation environment (degree of vibration and so on) and the weighing application (whether solid objects / clumps or poured liquids / powders are being weighed).

- Stability: The degree to which the weight reading is stable, with little fluctuation
- Response: The speed of the reaction to changes in the weight on the pan

Set the optimum conditions for your application by following the procedure below.

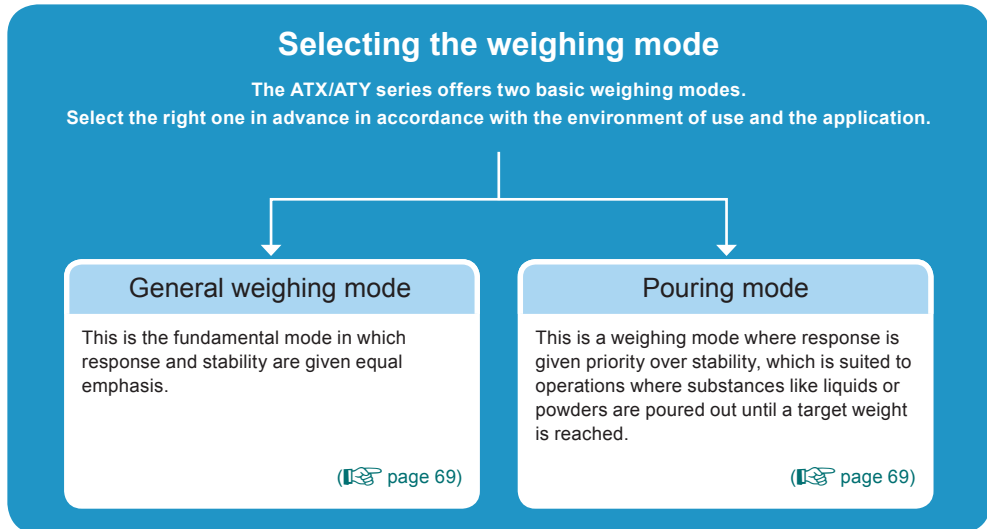

Adjusting the stability and response in real time during weighing

Pressing once in the weighing mode turns smart setting function on. By pressing and , you can adjust stability and response.

"Easy Setting of Response and Stability" page 70

Adjusting (the stability mark)

The conditions for making (the stability mark) light up (the stability detection range and the stability mark lighting timing) can be adjusted.

"Adjusting the Stability Mark" page 72

Selecting the Weighing Mode

ATX/ATY series balances have the following two types of weighing mode.

Set the right mode in advance depending on the environment of use and the weighing application.

Selecting the General Weighing Mode

This is the fundamental mode in which response and stability are given equal emphasis.

- 1 Press  twice in the weighing mode.

This opens the main menu.

- 2 Select the general weighing mode.



The balance has been set in the general weighing mode.

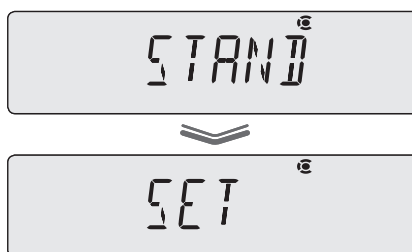

Selecting the Pouring Mode

This is the weighing mode suited to pouring out a sample (substance being weighed such as a powder or liquid) until a target weight is reached.

The update of the display is fast and the final value can be stabilized for reading.

- 1 Press  twice in the weighing mode.

This opens the main menu.

- 2 Select the pouring mode.



The pouring mode is established and  (the pouring symbol) lights up.

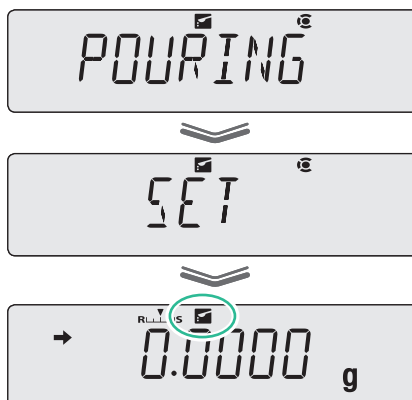



Easy Setting of Response and Stability



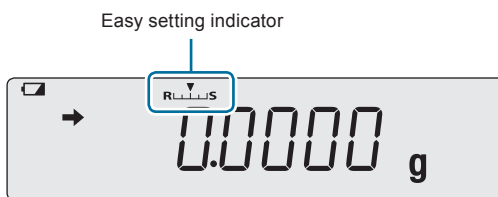

During weighing, the response and stability of the weighing mode can be adjusted in stages in accordance with the installation environment and the weighing application.

The ATX/ATY series balances feature excellent response and stability, but since response and stability are generally antagonistic, if one is prioritized it will to some extent weaken the characteristics of the other.

Easy Setting allows quick adjustment to match your preference, requirements or particular application.



Pressing  in the weighing mode flashes the smart setting indicator and turns the smart setting on. Then, you can perform operations as in the table below.

 Pressing  again (pressing  twice in the weighing mode) enters the main menu. In this case, press  and return to the weighing mode.

Smart setting function automatically turns off if there is no key operation after a certain period of time.

This functions can also be turned off by pressing .

Priority Given to Response	↔	Priority Given to Stability
	Easy setting indicator	
Press The more times you press this key, the further ▼ (the level indicator) moves to the R side, increasing the response of the display in stages.	Operation	Press The more times you press this key, the further ▼ (the level indicator) moves to the S side, increasing the stability of the display in stages.
<ul style="list-style-type: none"> • When you want to weigh things quickly • When you want to improve working efficiency • When weighing out target quantities of a liquid or powder or when making a formulation 	For these circumstances...	<ul style="list-style-type: none"> • When you want to weigh things with confirmed accuracy • When the display is unstable • When the balance is used in a location where there is a constant and relatively large vibration • When the balance is subject to constant air movements and the indication wavers

BEFORE WEIGHING

USING THE BALANCE

USING MORE CONVENIENTLY

MAINTENANCE

TROUBLESHOOTING

FOR YOUR INFORMATION

Adjusting the Stability Mark

The stability mark is a symbol (↔) that is displayed when it is determined that the weight reading has stabilized.

The following settings adjust conditions for lighting up of ↔ (the stability mark).

- Stability detection range
- Stability mark lighting timing

Normally there is no need to change these settings. (Change the settings if, for example, you want to relax the conditions and make ↔ (the stability mark) light more easily because the environment is unstable, or to speed up operation if stability is used to automatically print or output data.



Lighting up of ↔ (the stability mark)

The lighting up of ↔ (the stability mark) indicates the fact that the weight reading is stable. If the load is being changed slowly, or due to the settings relating to stability detection, the weight reading may change while ↔ (the stability mark) remains lit, or ↔ (the stability mark) may light temporarily and then the weight reading may change.

Setting the Stability Detection Range

The stability detection range is a value set as a count of the smallest digit that is displayed, and the display is judged to be stable if fluctuation in the weight reading is within this count during a fixed time.

(The default setting for the stability detection range is 1 count (1d).)

Effect of reducing the stability detection range

It takes some time for ↔ (the stability mark) to light up, but after it has lit the weight reading is stable (improvement in reliability).

Effect of increasing the stability detection range

↔ (the stability mark) can be made to light more quickly but the weight reading is liable to fluctuate after it has lit (improvement of weighing and data output speeds).

1 Press twice in the weighing mode.

This opens the main menu.

2 Select setting of the stability detection range.

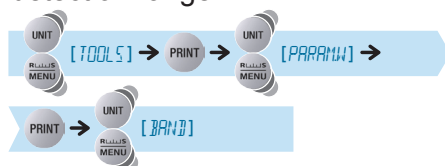

3 Select the value for the stability detection range.

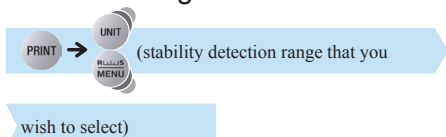

Select the stability detection range from among the following options depending on the weighing application and purpose: 0.5d, 1d, 10d, 50d, 100d, 1000d.

4 Confirm and return to the weighing mode.



The stability detection range has now been set.



Upon setting, the stability mark lights up.



If data output is slow...

There are factors in the installation environment and the sample that make the display unstable. If data output triggered by stability detection is very slow, increase the stability detection range.

Setting the Stability Mark Lighting Timing

The timing according to which \Rightarrow (the stability mark) lights can be set in accordance with the application and required accuracy.



Not applicable to a verified balance as a legal measuring instrument.

Effect of speeding up the timing for lighting up of the stability mark

At the same time as stability is detected, \Rightarrow (the stability mark) lights up. The weight reading after \Rightarrow (the stability mark) lights up becomes more susceptible to fluctuation since many samples can be weighed in succession and the working time can be used more efficiently (improvement of weighing speed).

Effect of setting the stability mark lighting timing to the standard setting

When stability is detected and remains detected for a fixed time, \Rightarrow (the stability mark) lights up. \Rightarrow (the stability mark) lighting judgments become stricter and the weight reading is stable after it has lit, so highly accurate weighing is possible (improvement of reliability of data).

6 ADJUSTING RESPONSE AND STABILITY

▽ Adjusting the Stability Mark

1 Press  twice in the weighing mode.

This opens the main menu.

2 Select setting of  (the stability mark) lighting timing.

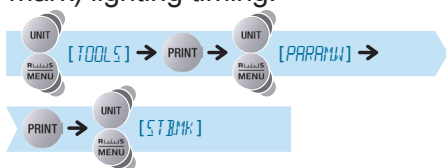

3 Check the lighting timing setting.

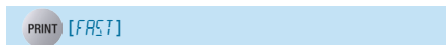

Stability Mark	Stability Mark Lighting Timing
Lit	Fast
Unlit	Standard

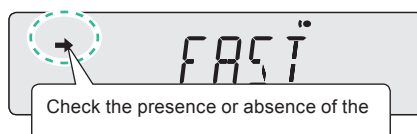

4 Change  (the stability mark) lighting timing.

Pressing  alternately sets the "fast" and "standard" settings.

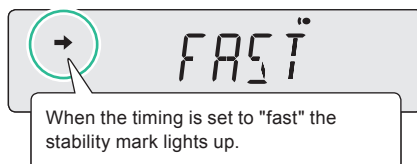
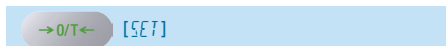

5 Return to the weighing mode.



BEFORE
WEIGHING

USING THE
BALANCE

USING MORE CONVENIENTLY

MAINTENANCE

TROUBLESHOOTING

FOR YOUR
INFORMATION

MEMO

7 SETTING UNITS

ATX/ATY series balances can be made to indicate weights in units other than the basic units of grams by switching units with the  key in the weighing mode.

You must register the units you will require in advance.

On shipment from the factory, the only unit registered is g (grams).

 "Switching Units", page 35

Units That Can Be Displayed and Conversion Factors

Some of the units below cannot be selected in some countries due to legal restrictions.

Weight Unit (Weight Name)	Gram Conversion ^(*)	Conversion Factor ^(*)
g (gram)	1	1
mg (miligram)	0.001	1000
ct (carat) ^{*3}	0.2	5
mom (momme) ^{*6}	3.75	0.2666667
oz (ounce) ^{*6}	28.34955	0.035274
ozt (troy ounce) ^{*6}	31.1035	0.0321507
dwt (pennyweight) ^{*6}	1.55517	0.643015
GN (grain) ^{*6}	0.064799	15.4324
HTI (Hong Kong tael) ^{*6}	37.429	0.0267173
STI (Singapore tael) ^{*6}	37.79936	0.0264554
TTI (Taiwan tael) ^{*4,*6}	37.5	0.0266667
MTI (Malaysian tael) ^{*6}	37.79289	0.0264600
m (mesghal) ^{*6}	4.6083	0.216999
o (parts pound) ^{*6}	0.88592	1.12877
B (baht) ^{*6}	15.2	0.0657895
S (sawaran) ^{*6}	7.999	0.1250156
Ks (kyats) ^{*6}	16.606	0.0602191
T (tola) ^{*6}	11.664	0.0857339
User ^{*5,*6}		Can be set as required by the user ^(*)

*1 If we take the value in the Gram conversion column to be "a", the formula is as follows.

"a" × balance weight reading (each unit) = value in gram units

*2 If we take the conversion factor to be "k", the formula is as follows.

"k" × value in gram units = balance weight value (selected units)

*3 The minimum indication for ct (carat) may vary depending on the production lot even if they are the same model. Not applicable to verified balance as a legal measuring instrument of ATX84 and ATY64.

*4 There are five kinds of Taiwan tael (TTL-1 to TTL-4).

The conversion factor is the same, but the minimum indication is as follows

TTL-1 A value 5 times that of TTL-2

TTL-2 The minimum value

TTL-3 A value twice that of TTL-2

TTL-4 A value 10 times that of TTL-2

*5 With user-specified units, the conversion factor (*2) and minimum indication can be set as required.

For details on the method for setting user-specified units, see "Setting User-Specified Units" ( page 78).

*6 Not applicable to a verified balance as a legal measuring instrument.

Selecting Units to Display

Select and set the units you require to display so that they can be called up by pressing **UNIT** during weighing operation.

For details on user-specified units, see "Setting User-Specified Units" (👉 page 78).

- 1 Press **UNIT** for about 3 seconds in the weighing mode.

This opens the unit setting menu.

- 2 Select the units to be called up and check if → (the stability mark) is displayed or not.

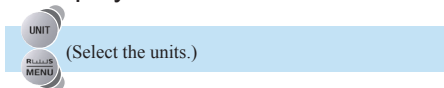

Stability Mark	Registering Units
Lit	ON
Unlit	OFF



Check the presence or absence of the stability mark.

- 3 Change the setting for units.

Pressing **→/T←** alternately sets the ON and OFF settings.

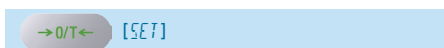

To set or cancel other units, go to step 2.
To quit, go to step 4.



When ON is set the stability mark is lit.

- 4 Return to the weighing mode.



- 5 Press **UNIT** to call up selected units.

👉 "Switching Units", page 35

Setting User-Specified Units

 Not applicable to a verified balance as a legal measuring instrument.

Conversion Factors

Numerical values (multipliers) by which the weight reading (in grams) is multiplied can be set without restriction.

1 Press  for about 3 seconds in the weighing mode.

This opens the unit setting menu.

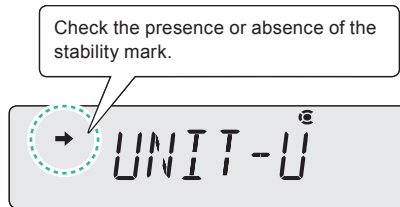
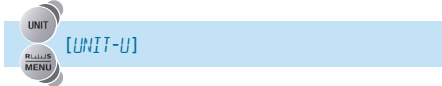

2 Select the user-specified units.



What is the current situation?

Stability Mark	User-Specified Units
Lit	Set
Unlit	Cancelled

What do you want to do?

To Set / Update	To Cancel
Press  and go to step 3.	Press  and go to step 5.
 and go to step 3.	Go to step 5.

3 Select setting of the conversion factor.



4 Enter the conversion factor.

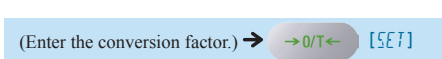

 "Entering Numerical Values", page 43

 Changing the position of the decimal point

When entering a conversion factor, the position of the decimal point can be changed ( page 44).





Calculation formula for the conversion factor

If we take the conversion factor to be "k" the formula is as follows.
 "k" × value in gram units = balance weight reading (user-specified units)

5 Return to the weighing mode.



6 Press **UNIT** to call up the user-specified units.

"Switching Units", page 35



When user-specified units are called up, no indication of units is given.

Minimum Indication

You can set the minimum weight reading display for the user-specified units.

Make the setting by replacing steps **3** and **4** of the conversion factor procedure (page 78) with the following procedure.

3 Select setting of the minimum indication.



4 Enter the minimum indication.

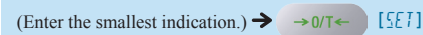

"Entering Numerical Values", page 43



5 Return to the weighing mode.



The minimum weight reading display for the user-specified units is ...

This can be set to any required value but in some cases it will not be possible to guarantee the stability of the weight reading display.

8

APPLICATION FUNCTION MODE

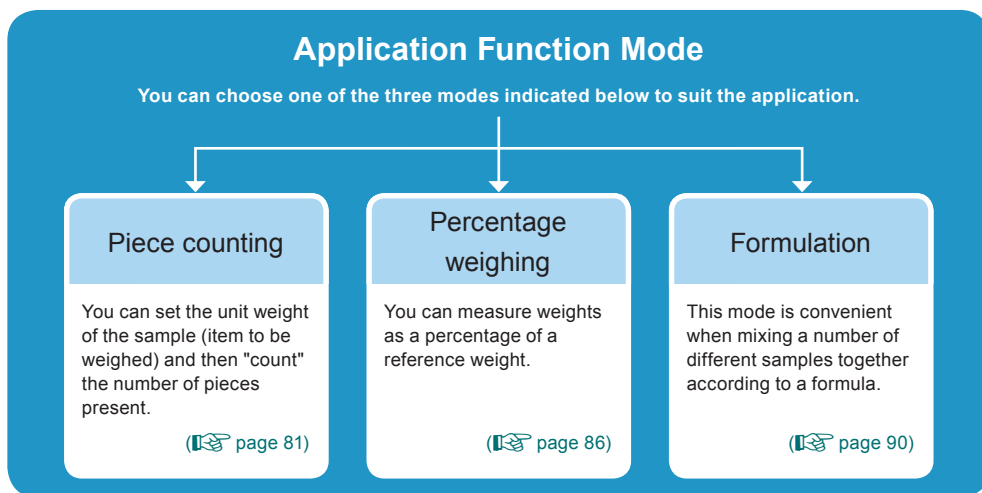

When the application function mode is set...

- ◆ Pressing for 3 seconds alternately selects the weighing mode (gram or other unit indication) and the application function mode in use.
- ◆ It can be used in combination with the comparator function (page 96).
- ◆ If the power is turned OFF and back ON the balance will start up in the weighing mode but the application function mode settings will be retained.
- ◆ Pressing twice in the weighing mode displays the setting menu for each application function mode. If you then press or , the top hierarchical level of the main menu appears.

The flow of the operation for displaying the menu is shown below.

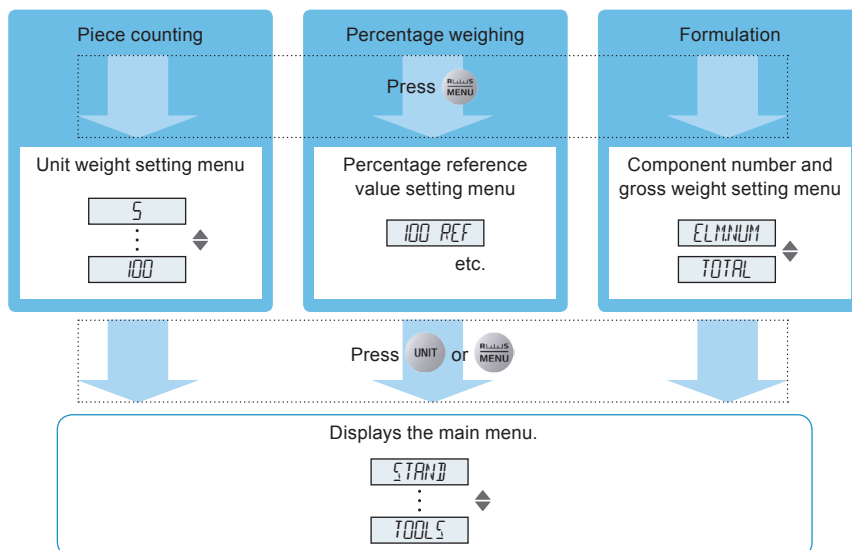

Counting Pieces by Weight (Piece Counting)

You can set the unit weight (weight of a single piece) of the item in advance and then display the number of pieces in the sample.

The unit weight is recorded by placing a sample on the pan that comprises the "number of pieces used for setting".

Unit weights for up to five different types of items can be set at the same time.



Points where care is necessary

- ◆ If the sample is spread out too much or unevenly in the container on the pan, accurate piece counting will not be possible.
- ◆ If a large quantity sample is to be weighed, and the quantity in the sample greatly exceeds the quantity used to set the unit weight, there may be a large counting error.



To minimize the counting error...

- ◆ In step **5** of "Preparation for Piece Counting", make the number of pieces used for setting the unit weight as large as possible.
- ◆ When actually measuring numbers of pieces, don't place a large quantity of the sample on the pan at one time but rather add a small portion at a time and, when the display has stabilized, press  for at least 3 seconds to update the unit weight. Keep repeating this operation.

Preparation for Piece Counting (Including Setting the Unit Weight)

The preparations for piece counting are explained here. Only make the setting in the following circumstances.

- You are performing piece counting for the first time.
- You are switching from another application function mode to piece counting.

1 Enter the weighing mode and press  twice.

This opens the main menu.

2 Select piece counting.

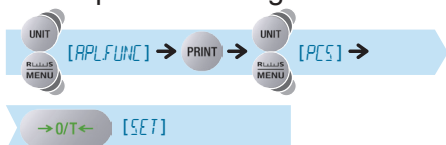

▽ Counting Pieces by Weight (Piece Counting)

3 Select the item number.

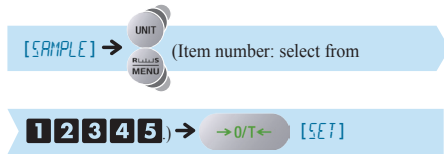

Five different unit weight settings (12345) can be recorded.



4 Check the number of pieces indication.

The display will indicate whether a unit weight has already been set.

When no unit weight has been set for the item number:

[---]



When a unit weight has already been set for the item number:

(The number of pieces is indicated.)

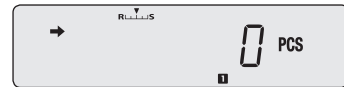

- To update the unit weight, proceed to step 5.
- If you are not intending to update the unit weight, the procedure from step 5 on is unnecessary. You can start piece counting right away.

"Counting Numbers of Pieces", page 84

5 Place the container on the pan and press → 0/T ←

6 Select the number of pieces used for setting.

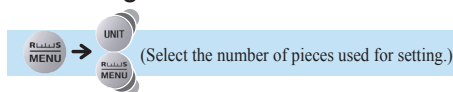

Number of pieces used for setting

The number of pieces used for setting can be selected from among 5 pieces, 10 pieces 100 pieces.

In order to minimize counting error, make the number of pieces used for setting the unit weight as large as possible.



On pressing UNIT or MENU ...

A menu option other than the number of pieces for setting may be displayed but this is not abnormal.

Press UNIT or MENU several times to return to the number of pieces for setting display.

7 Put a quantity of the item to be counted corresponding to the selected "number of pieces used for setting" into the container.

8 Check that **→** (the stability mark) lights up, then confirm.

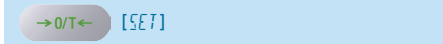

The unit weight will be set and the number of pieces of the sample will be indicated. You can now start piece counting.

 "Counting Numbers of Pieces", page 84

If you wish to add the unit weight for another item to be counted, see "Changing a Unit Weight, or Adding a New Unit Weight" ( page 85).



▽ Counting Pieces by Weight (Piece Counting)

■ Counting Numbers of Pieces

1 Enter the piece counting mode

If you have returned to the weighing mode (mode where grams or other units are displayed) from the piece counting mode, then long press

 **3** /sec. for about 3 seconds to enter the piece counting mode.



The piece counting symbol will light up.



If the piece counting mode is not established...

The preparations for piece counting have not been completed. Make settings according to "Preparation for Piece Counting (Including Setting the Unit Weight)" ( page 81).

2 Select the item number.

Each time  **3** /sec. is pressed for about three seconds, the selection moves to the next item number and the corresponding item number indication (from **1** to **5**) is displayed.

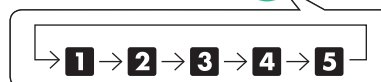

If the display appears as shown to the right...

This means that the unit weight has not been set for the selected item number. To make this setting, follow the procedure in "Changing a Unit Weight, or Adding a New Unit Weight" ( page 85).







3 Place a container on the pan and press

The balance will be tared.

4 Add the sample to be counted into the container.

The number of pieces in the sample is indicated.

The operations of each of the keys after setting are summarized below.

On pressing  twice.	Establishes the unit weight setting menu. ( step 3 onward on page 85.)
On pressing  ...	Pressing this key alternately displays the set unit weight (in grams) and the number of pieces. Press  while the unit weight is displayed to output the unit weight. While the unit weight is displayed,  (the hold display symbol) is displayed.
On long pressing  3 /sec. ...	The weighing mode is established. Pressing the key once more returns you to the piece counting mode.

■ Changing a Unit Weight, or Adding a New Unit Weight

1 Establish the piece counting mode.

In the weighing mode (mode where grams or other units are displayed), long press

 **3** sec. to switch to the application function mode.



2 Select the item number whose unit weight you want to change, or for which you want to add a unit weight.

Each time you press  for about 3 seconds, the next item number is displayed.

 "Counting Numbers of Pieces", page 84

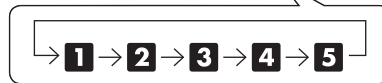

3 Place the container on the pan and press .

The balance will be tared.

4 Press twice.

The number of pieces used for setting will be displayed.



5 Select the number of pieces used for setting.

 (Select the number of pieces used for setting.)



6 Put a quantity of the item to be counted corresponding to the selected "number of pieces used for setting" into the container.

7 Check that (the stability mark) lights up, then confirm.

 [SET]



The unit weight will be added, and piece counting will become possible.

Percentage Weighing

In this mode the weight of the sample is converted to a percentage of the reference weight. The following two setting methods are available for percentage weighing.

100% Reference	The reference weight is set as 100%.
Specific Percentage Reference	The reference weight is set as a percentage value of your choice.

■ Preparation for Percentage Weighing

- 1** Press  twice in the weighing mode.

This opens the main menu.

- 2** Select percentage weighing.

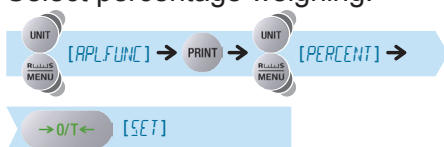

The setting beyond this point differs depending on the percentage value you are assigning to the reference weight.

If the reference weight is being set as 100%, see "When setting the reference as 100%..." (👉 page 87).
 If the reference weight is being set as a specific percentage, see "When setting the reference as a percentage of your choice..." (👉 page 86).

When setting the reference as 100%...

3 Select the 100% reference.



(Check the indication.)

The indication differs depending on whether a reference value has already been set or not.

When no percentage reference value has been set

[---



When a percentage reference value has already been set

(The percentage reference value is displayed.)



- To update the percentage reference value, proceed to step 4.
- If you are not updating the percentage reference value, the following steps are not necessary.

"Weighing Percentages", page 89

4 Place the container on the pan and press

The balance will be tared.

5 Select 100% reference setting.

Press twice [100 REF]



6 Place the sample that is to provide the reference weight in the container.

7 Check that (the stability mark) lights up, then confirm.

[SET]

A percentage value with the reference weight taken to be 100% is displayed.
Percentage Weighing is now possible.

"Weighing Percentages", page 89



What to do if...

It is not possible to use a reference weight that weighs less than 100 times the minimum indication of the balance as the reference weight.

▽ Percentage Weighing

When setting the reference as a percentage of your choice...

3 Select the specific percentage reference.



(Check the indication.)

The indication differs depending on whether a reference value has already been set or not.

When no percentage reference value has been set

[---]



When a percentage reference value has already been set

(The percentage reference value is displayed.)



- To update the percentage reference value, proceed to step 4.
- If you are not updating the percentage reference value, the following steps are not necessary.

"Weighing Percentages", page 89

4 Place the container on the pan and press .

The balance will be tared.

5 Enter a percentage value of your choice.

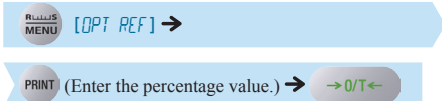

"Entering Numerical Values", page 43

6 Place the sample that is to provide the reference weight in the container.

7 Check that (the stability mark) lights up, then confirm.



A percentage value calculated by conversion on the basis that the reference weight is equal to the set percentage is displayed.

Percentage weighing is now possible.

"Weighing Percentages", page 89



The specific percentage weighing symbol lights up.



What to do if...

It is not possible to use a reference weight such that the weight corresponding to 100% is less than 100 times the minimum indication of the balance.

■ Weighing Percentages

1 Establish the percentage weighing mode.

If you have returned to the weighing mode (mode where grams or other units are displayed) from the percentage weighing mode, then long press

 **3** sec. for about 3 seconds to enter the percentage weighing mode.

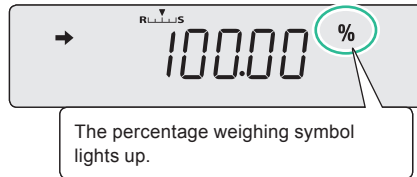

If the percentage weighing mode is not established...

The preparations for percentage weighing have not been completed. Make setting in accordance with "Preparation for Percentage Weighing" ( page 86).







2 Place the container on the pan and press

The balance will be tared.

3 Insert the sample (item to be measured) into the container.

A percentage value obtained by conversion based on the set reference percentage value and reference weight is displayed.

The operations of each of the keys after setting are summarized below.

On pressing  twice.	The percentage reference value setting menu is displayed. ( step 4 onward on pages 87 and 88.)
On pressing  ...	The set reference weight (in grams) and the percentage indication are displayed alternately. Press  while the reference weight is displayed to output the reference weight. While the reference weight is displayed, * (the hold display symbol) is displayed.
On long pressing  3 sec. ...	The 100% reference and specific percentage value are displayed alternately.
On long pressing  3 sec. ...	The mode is switched to the weighing mode. Pressing the key again will return you to the percentage weighing mode.

Formulation

This function is useful when mixing multiple components together by weight, according to a formula. Use this function while the printer is connected to a printer or PC.

The weight of each component is measured and output or added, and on completion of the formulation the gross weight is output.

During formulation the auto zero function (👉 page 64) will not work.

Performing Formulation

1 Press **MENU** twice in the weighing mode.

This opens the main menu.

2 Set the balance to the formulation mode.

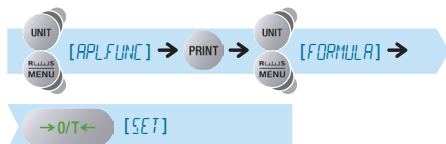

The balance is now ready to weigh. If necessary, set output of the component numbers and output of the gross weight.

👉 "Outputting Component Numbers", page 93

👉 "Outputting the Gross Weight", page 94

3 Place the container on the pan and press **→O/T←**

The balance will be tared.

4 Press **PRINT**
Formulation starts.



The formulation symbol lights up.



The ready symbol lights up, indicating that the balance is ready to weigh.



The ready symbol goes out.

 When the GLP output function ( page 135) is set to ON...
The balance ID ( page 137) and other information is printed.

5 Insert the component into the container.



6 Press . The weight value of the current sample (item to be weighed: element) is output / recorded and the balance is automatically tared.







Now repeat the operations in steps **5** and **6** to add the other components to the formulation.

7 On completion of formulation, press .

The total of the individual weight values up to this point (gross weight) is displayed and the balance returns to the ready to weigh status.



 To output the gross weight...
Make the setting in "Outputting the Gross Weight" ( page 94) in advance.

 When the GLP output function ( page 135) is set to ON...
The signature panel is printed after the total weight.

▽ Formulation

The operation after setting is as follows.

When in the ready to weigh status:

 <p>On long pressing</p>	<p>The weighing mode is established. Long pressing the key once more returns you to the ready to weigh status.</p>
---	--

When weighing is in progress:

 <p>On pressing</p>	<p>The gross weight of the components weighed up to that point is displayed for about 2 seconds.</p>
--	--

Example printout from printer
(When the GLP output function is set to ON)

FORMULATION MODE

Name of manufacturer — SHIMADZU CORP.
 Balance model name — TYPE ATX224
 Balance serial number — SN D*****
 Balance ID — ID 1234

CMP001= 0.9000g
 CMP002= 1.2800g
 CMP003= 9.6100g
 TOTAL= 11.7900g

-SIGNATURE-

~ ~ ~ ~ ~



The person who carried out measurement signs here.

Outputting Component Numbers



The numbers for each component are automatically assigned to the output results.

- 1 Press  twice in ready to weigh status while in the formulation mode.

This opens the main menu.

 If the ready to weigh status is not established...
Perform steps **1** and **2** of formulation ( page 86).

- 2 Select component number output setting.

  [ELMNUM]

Stability Mark	Outputting Component Numbers
Lit	ON
Unlit	OFF

 ELMNUM
Check the presence or absence of the stability mark.

- 3 Change the output setting.

Pressing  alternately sets ON and OFF for the output setting.

 [SET]

SET

 ELMNUM
When ON is set the stability mark is lit.

- 4 Return to ready to weigh status.

 or  3 sec.

FORMULATION MODE

CMP001=	0.6280g
CMP002=	0.6280g
CMP003=	0.6810g
CMP004=	0.6680g
CMP005=	0.6590g
TOTAL=	3.2640g

Component number

Weight reading for each component (output regardless of the ON/OFF status of component number output)

■ Outputting the Gross Weight

The gross weight for a formulation weighing operation is output at the same time it is displayed. The gross weight is output together with the printed indication: "TOTAL =".

- 1 Press  twice in ready to weigh status while in the formulation mode.



This opens the main menu.



If the ready to weigh status is not established...

Perform steps **1** and **2** of formulation ( page 86).

- 2 Select gross weight output setting.

  [TOTAL]

Stability Mark	Outputting the Gross Weight
Lit	ON
Unlit	OFF

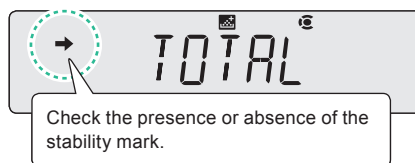

- 3 Change the output setting.

Pressing  alternately sets ON and OFF for the output setting.

 [SET]

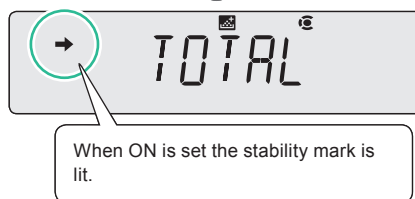

- 4 Return to ready to weigh status.

 or  3 sec.

FORMULATION MODE

CMP001= 0.6280g

CMP002= 0.6280g

CMP003= 0.6810g

CMP004= 0.6680g

CMP005= 0.6590g

Gross weight — TOTAL= 3.2640g

BEFORE WEIGHING

USING THE BALANCE

USING MORE CONVENIENTLY

MAINTENANCE

TROUBLESHOOTING

FOR YOUR INFORMATION

MEMO

9

COMPARATOR FUNCTION

The comparator function performs a comparison between the weight reading and a reference value or target value and displays the status of this comparison.

Comparator Function

You can select and use either of these modes according to the environment of use and application.

Target mode

After setting a target value and a tolerance range with respect to that target value, excesses and deficits in relation to the target value are indicated by **HI**, **OK** and **LO** (the comparator symbols).

(👉 page 96)

Checkweighing mode

After setting the threshold values at the upper and lower limits of the pass range, when a sample is weighed a pass or fail determination is indicated by **HI**, **OK** and **LO** (the comparator symbols). An out of range determination is indicated by all comparator symbols OFF.

(👉 page 98)



Before setting the comparator function

- ◆ It can be used in combination with the application function mode (👉 page 80).
- ◆ If you are already using the application function mode, read "When the application function mode is set..." (👉 page 80).
- ◆ The comparator function settings are retained even if the power is switched off.

Target Mode

1 Press **RECALL MENU** twice in the weighing mode.
This opens the main menu.

2 Select the target mode.



Check the presence or absence of the stability mark.



What is the current situation?

Stability Mark	Target Mode
Lit	ON
Unlit	OFF

What do you want to do?

To Set / Update	To Cancel
Press PRINT and go to step 3 .	Press →0/T← and go to step 4 .
Press →0/T← and go to step 3 .	Go to step 4 .

3 Enter the target value and the tolerance range with respect to the target value.

 "Entering Numerical Values", page 43

When entering the target value:

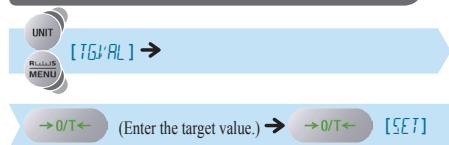

When entering the tolerance range with respect to the target value:

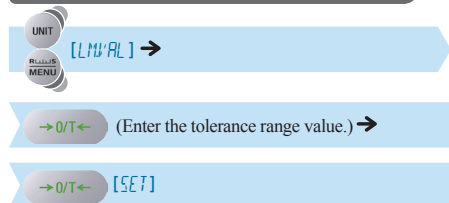

4 Return to the weighing mode.

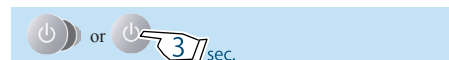

5 Place the container on the pan and press .

The balance will be tared.

6 Insert a sample into the container.

Excess or deficiency is determined according to the the following conditions.

The comparator symbols light in accordance with the excess/deficiency judgment.



Condition	Judgment	Comparator Symbol
Over the target value range	Large difference with respect to the target value	HI (flashes slowly)
	Small difference with respect to the target value	HI (flashes quickly)
Within the target value range (target value \pm permissible range)	Acceptable	OK
Under the target value range	Small difference with respect to the target value	LO (flashes quickly)
	Large difference with respect to the target value	LO (flashes slowly)

Checkweighing Mode

- 1 Press  twice in the weighing mode.

This opens the main menu.

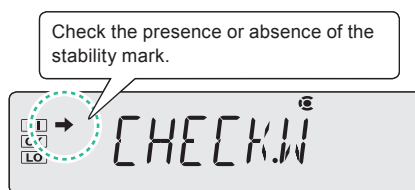
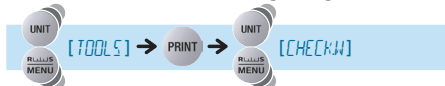

- 2 Select the checkweighing mode.



What is the current situation?

Stability Mark	Checkweighing Mode
Lit	ON
Unlit	OFF

What do you want to do?

To Set / Update	To Cancel
Press  and go to step 3.	Press  and go to step 4.
Press  and go to step 3.	Go to step 4.

- 3 Enter the pass range upper limit value and lower limit value, and the checkweighing range lower limit value and checkweighing range upper limit value.

 "Entering Numerical Values", page 43

To enter the pass range upper limit value:



To enter the pass range lower limit value:

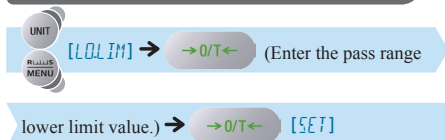

To enter the checkweighing range lower limit value:

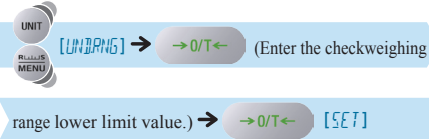

To enter the checkweighing range upper limit value:

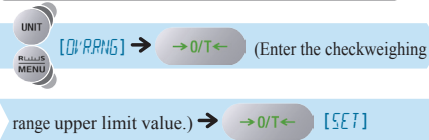

Be sure to double check all values.

If the entered values don't go together logically, for example if a value lower than the lower limit value is entered as the upper limit value, the values will be automatically corrected and other values will be set.

Particular care is required when entering new values where settings have been made before (updating).

4 Return to the weighing mode.



5 Place the container on the pan and press

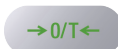

The balance will be tared

6 Insert the sample (item to be measured) into the container.

Pass or fail determination is based on the following conditions.

The comparator symbols light in accordance with the pass or fail determination.



Condition	Result	Comparator Symbol
Upper limit value of the checkweighing range < indication	Out of Range	All off
Upper limit value of the pass range < indication ≤ upper limit value of the checkweighing range	HI	HI
Lower limit value of the pass range ≤ indication ≤ upper limit value of the pass range	PASS	OK
Lower limit value of the checkweighing range ≤ indication < lower limit value of the pass range	LO	LO
indication < lower limit value of the checkweighing range	Out of Range	All off

With ATX/ATY series balances, weight readings, settings and other data can be output to a personal computer or a printer. This section describes some convenient functions relating to output, and how to connect the balance to a PC or printer.

Use an optional dedicated printer. To connect to a PC, you need the optional RS-232 interface IFB-102A-UNC and the RS-232C cable.

Convenient Functions Relating to Output

Printing / Outputting Automatically (Auto Print Function)

This function allows you to automatically output the displayed weight reading at each weighing without pressing .

Select the output timing from among the following five modes.

	Stable Positive Value	Stable Negative Value	Stable Zero Indication	Pass in Checkweighing Mode	Explanation
Mode 1 <i>L 11 .</i>	<input type="radio"/>				When stability is detected with a positive value, the value is output.
Mode 2 <i>L 11.11.</i>	<input type="radio"/>	<input type="radio"/>			When stability is detected with a positive or negative value, the value is output.
Mode 3 <i>L 11 .Z</i>	<input type="radio"/>		<input type="radio"/>		When stability is detected with a positive value, or when the reading has returned to zero, the value is output.
Mode 4 <i>L 11.11.Z</i>	<input type="radio"/>	<input type="radio"/>	<input type="radio"/>		When stability is detected with a positive or negative value or when the reading has returned to zero, the value is output.
Mode 5 <i>L 11.0K.</i>				<input type="radio"/>	When the auto print function is used in combination with the checkweighing mode ( page 98) and stability is detected with an "OK" determination, the value is output.

: Output, Blank: Not output

- 1 Press  for about 3 seconds in the weighing mode.

This opens the output menu.

2 Select the auto print function.

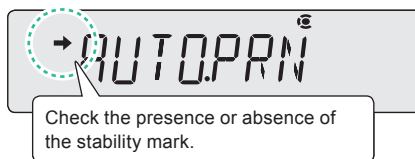
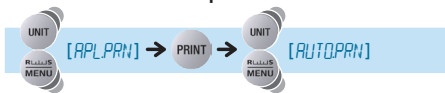

Check the presence or absence of the stability mark.

What is the current situation?

Stability Mark	Auto Print Function
Lit	ON
Unlit	OFF

What do you want to do?

To Set / Update	To Cancel
Press PRINT and go to step 3 .	Press →0/T← and go to step 5 .
Press →0/T← and go to step 3 .	Go to step 5 .

3 Select the mode for output timing.

Select the output timing from among mode 1 to mode 5 (see the table on the previous page).

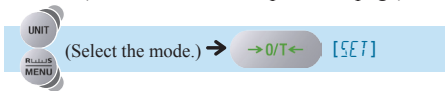

As an example, assume here that mode 3 is selected (output with a stable positive value or a stable zero indication).

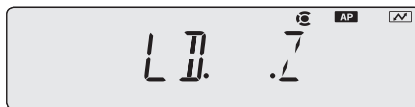

4 If necessary, set zero return requirement.

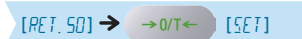

What is zero return requirement?

After the previous sample (item to be weighed) has been removed from the pan, the weight reading must fall below the zero value and stability must be achieved before the next sample is placed on the pan, otherwise there will be no automatic output for this next sample. This function is intended to prevent two or more outputs being made for the same sample. For the zero return value, select either zero or 50% of the weight of the immediately preceding sample. Setting 50% saves time because even if the display doesn't return to zero, as long as stability is achieved, output will be possible if the next sample is placed on the pan.



- When "RET. 0" is set:



If you are not setting zero return requirement, proceed to step **5**.

▽ Convenient Functions Relating to Output

5 Return to the weighing mode.

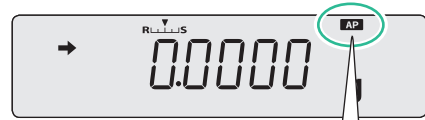

When the setting is made, the auto print symbol lights up.

6 Place the container on the pan and press 

The balance will be tared.

7 Place the sample into the container.

After  (the stability mark) lights up, the displayed weight reading is automatically output.

8 Remove the sample from the pan.

If  (the stability mark) lights up at a value close to zero, the displayed weight reading is automatically output.

■ Printing / Outputting Continuously (Continuous Output Function)

This function allows displayed weight readings to be automatically output continuously in the same timing as the display refresh cycle (approximately 100 msec intervals) while weighing, without having to press 

 Not applicable to a verified balance as a legal measuring instrument.

1 Press   for about 3 seconds in the weighing mode.

2 Select the continuous output function.

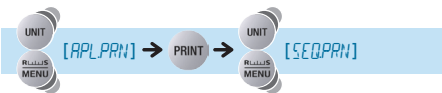

Check the presence or absence of the stability mark.

Stability Mark	Continuous Output Function
Lit	ON
Unlit	OFF

3 Change the setting.

Pressing  alternately sets the ON and OFF settings.



If OFF is selected, perform step **6**. Steps **7** onward are not necessary in this case.



4 Set whether starting and ending of the continuous output is performed manually by key operation.



Pressing  alternately sets the ON and OFF settings.

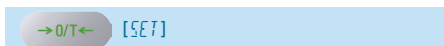

5 Set whether the non-averaged value is output as a continuous output value.

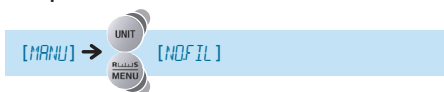

Pressing  alternately sets the ON and OFF settings.

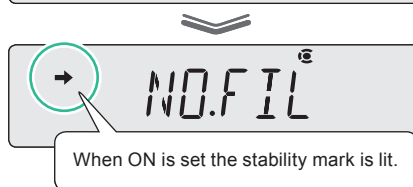
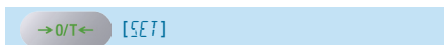

▽ Convenient Functions Relating to Output

6 Return to the weighing mode.



When OFF is set for "MANU" in step 4, continuous output starts.

Step 8 is not necessary in this case.

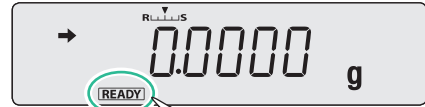

When ON is set for "MANU" in step 4, the ready symbol lights up.

7 Place the container on the pan and press .

The balance will be tared.

8 Press (when ON is set for "MANU" in step 4).

After **READY** (the ready symbol) has gone off, displayed weight readings are continuously output.

9 Place the sample in the container.

Displayed weight readings will be automatically output in the same timing as the display refresh cycle (approximately 100 msec intervals).



Pausing and restarting the continuous output function

To pause the function, press .

To restart it, press .



When OFF is set for "MANU" in step 4...

"MANU" is set to ON when  is pressed and the continuous output function is temporarily stopped.



Operation of (the communication symbol)

During continuous output, it may appear as though  (the communication symbol) is continuously lit. Note also that if the transmission speed for data output is slow the display will be unstable and the response time of the balance will also be slow.



When connected to a printer...

For reasons linked to the performance of the printer, the data output interval will increase to longer than 100 msec.



This function cannot be used with Windows Direct Communication Function.

WindowsDirect Communication Function

What Is the WindowsDirect Communication Function?

In any Windows application (e.g. Excel or the weight input window of an analytical device), the numerical value displayed at the balance can be transferred to the cursor position just as if it had been entered from the keyboard. The main body of the balance has a keyboard function, so communication software is not required. As long as the status allows key entry, data can be directly sent to the target device.



To connect to a PC, the optional RS-232C Interface IFB-103A-UNC (P/N321-41167-20) and RS-232 Cable (P/N321-60754-01) are separately required.



What to do if...

- ◆ After installing communications software in the PC and attempting communications, it is not possible to use the WindowsDirect communication function even though the OS is Windows. Refer to communications setting as described in "User-Specified Settings" (👉 page 120).
- ◆ To control the balance from a PC, you must use command codes for programming (👉 page 114), not the WindowsDirect function.
- ◆ A dedicated tool is required in order to run the WindowsDirect communication function with Windows Vista. For details, contact your Shimadzu representative.

Setting the Function

- ◆ Making the settings at the balance

When this setting is made, all of the communications settings are changed to those appropriate for WindowsDirect communication. See "Communication Settings" (👉 page 119).

1 Press  for about 3 seconds in the weighing mode.

This opens the output menu.

2 Select WindowsDirect communication.

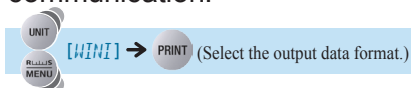

- When "WINI" has been selected:



▽ WindowsDirect Communication Function



When **→** (the stability mark) is lit up...

The output data format has already been set. If you proceed to the next step in this status the setting will be cancelled and the balance will return to the status immediately before setting.

There are four types of output data format.

Indication	Output Data Format
<i>WIN</i>	Numerical value + (ESC) + [enter.]
<i>WINU</i>	Numerical value, unit symbol (ESC) + [enter.]
<i>WIN-</i>	Numerical value + (ESC) + [tab.]
<i>WIN-U</i>	Numerical value, unit symbol + (ESC) + [tab.]



If you have selected a format with [ENTER] appended...

In some Windows applications, ENTER may cause the current window to close. If this is the case, select a format with [Tab] appended.

(ESC) : It means Escape sequence and describe "0x1b" in ASCII code.

3 Confirm and return to the weighing mode.



This completes the setting procedure at the balance.

When the function is set, **WIN** (the Win symbol) lights up.



◆ Connecting the RS-232C cable

1 Press  in the weighing mode. **READY** (the ready symbol) will light up and the standby mode will be established.

2 Remove the AC adapter from the power outlet.

3 Connect the optional RS-232 interface IFB-102A-UNC to the DATA I/O connector on the rear of the balance and connect the RS-232C cable to the IFB-102A-UNC.

4 Connect the RS-232C cable to the PC.

- ◆ Making the settings at the PC
As an example, the settings made with Windows XP are explained here.

1 Turn on the power to the PC

2 Click [start] (→ [Settings]) → [Control Panel].

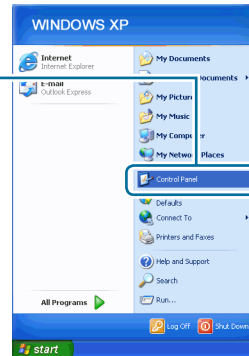

3 Click [Accessibility Options] in the Control Panel.

The [Accessibility Options] screen will be displayed.

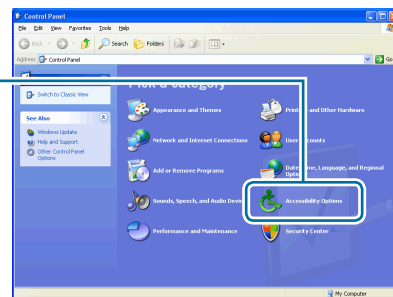

4 Enter a check mark at [Use Serial Keys] under the [General] tab.



In addition...

- ◆ If you find [Administrative options] under the [General] tab too, enter a check mark here as well as at [Use Serial Keys].
- ◆ Remove all check marks from all checkboxes under tabs other than the [General] tab.

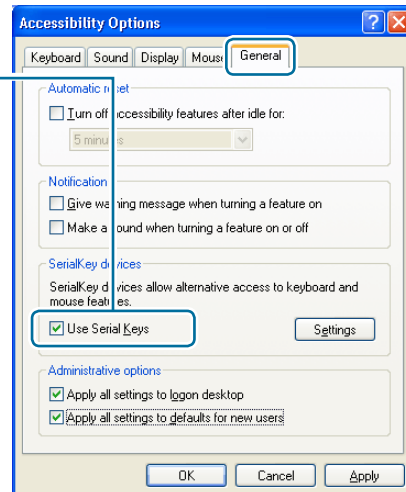

5 Clicks [Settings].

The [Settings for SerialKeys] dialog box will be displayed.

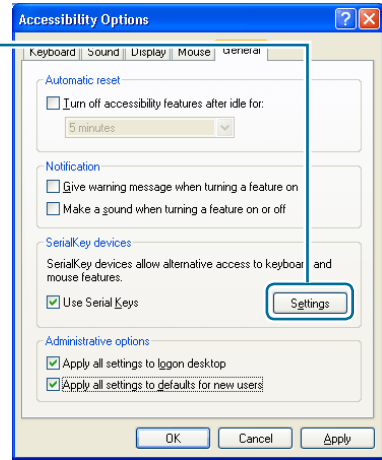

6 Select the serial port to be used for the connection with the balance and set the baud rate to "300".

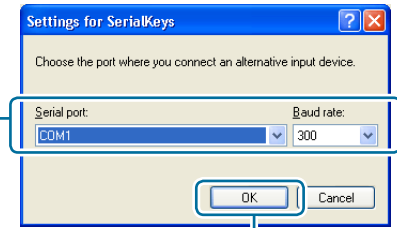

7 Click [OK].

Return to the [Accessibility Options] window.

8 Click [Apply].

Wait a short time until the [Apply] character color fades.

9 Click [OK].

This completes the settings at the PC.

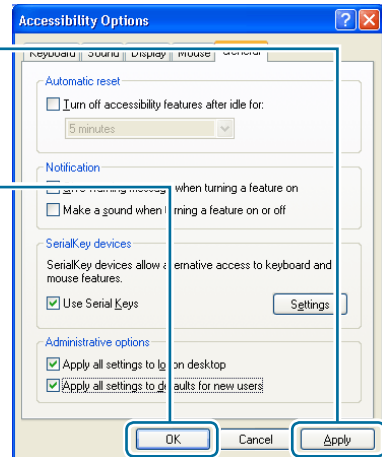

When the RS-232C port is used for another purpose...

Once a serial key device has been activated, other software that uses the same RS-232C port will not operate normally. If a device such as an external modem or a plotter is connected to the same RS-232C port, after connecting the balance you must remove the check mark from the [Use Serial Keys] checkbox to invalidate serial key devices.

◆ Checking operation

1 Connect the AC adapter to the power outlet.

The balance's self check display (👉 page 26) will be shown.

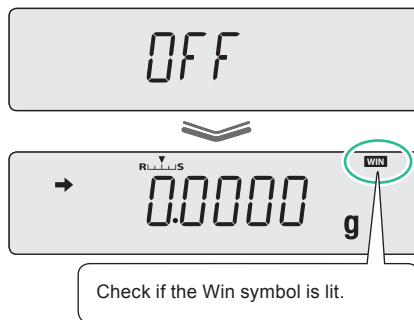
2 When [OFF] is displayed, press  to enter the weighing mode.**3** At the PC, start up Excel (or another application)

Key entry will be enabled and the cursor will be displayed at the position where entry is possible.

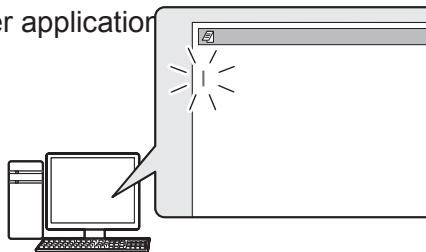
**4** Press  on the balance.

The numerical value displayed on the balance will be transferred to the cursor position.

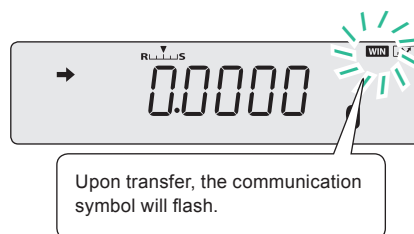

When the auto print function is used together with the WindowsDirect communication function...

Check that operation is normal even when using the auto print function.

👉 "Printing / Outputting Automatically (Auto Print Function)", page 100

Troubleshooting the WindowsDirect Communication Function

If the WindowsDirect communication function doesn't run properly, check the following points. If this doesn't resolve the problem, contact your Shimadzu representative.

Q1	WindowsDirect communication has been set but it is not operating at all.
A1	<ul style="list-style-type: none"> ● Check the type of communications cable used for the connection (Shimadzu authorized part or another part available on the general market) and the soundness of the connection. ● If a USB serial converter is used, depending on the circumstances at the setup there is a possibility that it has been automatically set to a COM port number higher than 4, and in this case you should reassign it to a COM port number that can be used by serial key devices (COM1 to COM4). ● It is possible that the driver used as an accessory with the USB serial converter has not been set up properly. Try uninstalling the driver and installing it again. ● Some notebook PCs feature a setting for disabling RS-232C ports as a power-saving measure. Before trying to use the WindowsDirect communication function, make the setting that enables the use of RS-232C ports. ● Communications with other applications and PCs via a LAN may interfere with the serial key device settings. Try using WindowsDirect communication without using the LAN.
Q2	The WindowsDirect communication function won't work after I restart the PC.
A2	<ul style="list-style-type: none"> ● Some PCs don't recognize that a serial key device has been set when they start up. For details on how to deal with this, contact your Shimadzu representative.
Q3	I want to use the WindowsDirect communication function with Windows Vista.
A3	<ul style="list-style-type: none"> ● Windows Vista doesn't have the serial device setting screen that is required to set the WindowsDirect communication function. For details on the setting, contact your Shimadzu representative.
Q4	Data is input to the PC as garbled characters.
A4	<ul style="list-style-type: none"> ● Either the balance or the PC is not set for the WindowsDirect connection function. Make the settings again by referring to "Setting the Function" (📖 page 105).
Q5	When data is input into Excel, the cursor doesn't move to another cell.
A5	<ul style="list-style-type: none"> ● If a function for conversion to 2-byte characters is available in Windows, turn the setting for this function off. ● Click the [Edit] tab under [Options] in Excel and check [Move selection after Enter] (if cells move in response to keyboard input there is no problem). ● Check the input data in another application (e.g. Notepad).
Q6	The operation is sometimes abnormal.
A6	<ul style="list-style-type: none"> ● Depending on the processing capability of the PC, malfunctions may occur if the communications speed is high. Set 300 bps for the communication speed. Malfunctions may also occur if the interval for data transmission from the balance is too short. Ensure that one batch of data is displayed on the screen before the next batch of data is sent. And if there is limited processing capability, don't use the continuous output function. ● When data is sent from the balance, don't touch the PC's keyboard or mouse.

Connecting to a PC (RS-232C)

Caution



To connect to a PC, the optional RS-232C Interface IFB-103A-UNC (P/N321-41167-20) and RS-232 Cable (P/N321-60754-01) are separately required.



Use a correctly connected cable.

Instructions

The connection method and special accessory RS-232C cable described below do not guarantee normal operation with all types of PC.

When using the WindowsDirect communication function, see "[WindowsDirect Communication Function](#)" ( page 105).

Cable Connection Method

- ◆ For IBM PC/AT, DOS/V, and AX PC (D-sub 9-pin) (Cross wire connection)

PC Side			Balance Side (RS-232C Interface)	
RXD	2	—————	2	TXD
TXD	3	—————	3	RXD
DTR	4	—————	6	DSR
SG	5	—————	7	SG
DSR	6	—————	20	DTR
RTS	7	⌋	5	CTS
CTS	8	⌋	4	RTS

Data Format

The details of the data format when standard setting 1 (*MODE.1*) or data format 2 (*DF.2*) in the user settings has been selected in the communication settings (🔗 page 119) are given below.

◆ Standard format

The data format when outputting negative values (for example: -123.4567 g) is as shown below. The delimiter is a carriage return.

The data length varies depending on the accompanying information, the number of characters used to indicate units, the delimiter and so on.

Data length for this example: 12 bytes

	①	②								③		④
Position	1	2	3	4	5	6	7	8	9	10	11	12
ASCII code	2DH	31H	32H	33H	2EH	34H	35H	36H	37H	67H	20H	0DH
Data	-	1	2	3	.	4	5	6	7	g		C/R

No.	Position	Explanation
①	Position 1 (sign)	If the value is positive " " (a space) is entered and if the value is negative "-" (a minus symbol) is entered.
②	Positions 2 to 9 (absolute values)	If not all of the eight locations are used for a numerical value, a code representing a space is entered at the blank positions, as shown in the example.
③	Positions 10 and 11 (units)	If the unit designation comprises one character, a code representing a space is entered at position 12. If the unit designation comprises three characters, a total of 14 characters is sent.
④	Position 12 (delimiter)	This is a code that represents the delimiter.

◆ When the data length is longer than the standard

When outputting data with stability information included

A code representing S or U is appended at the head of the data.

Accordingly, the data length is increased by one byte.

Position	1	2	3	4
ASCII code	53H	2DH	20H	31H
Data	S	-		1

When stable: S (53H)
When unstable: U (55H)

When the delimiter "C/R+L/F" is selected

Two bytes are required for the delimiter information.

One byte is added after position 12 in the standard format. Accordingly, the data length is increased by one byte.

Position	1	11	12	13
ASCII code	2DH	20H	0DH	0AH
Data	-		C/R	L/F

◆ When there is "OL" or "-OL" (overload) output

The data format when "OL" is included is shown below.

Data length for this example: 12 bytes

Position	1	2	3	4	5	6	7	8	9	10	11	12
ASCII code	20H	20H	20H	20H	20H	4FH	4CH	20H	20H	20H	20H	0DH
Data						O	L					C/R

When the information is "-OL" (minus overload), the entry at position 1 is changed from a space to "-" (a minus symbol, ASCII code 2DH).

▽ Connecting to a PC (RS-232C)

Command Codes

- ◆ Commands whose final character is a numeral, a letter of the alphabet, or a symbol other than "="

Each command code is sent to the balance with a delimiter appended at the end

Example 1:

P R I N T (C / R)	This is the same as pressing 
---------------------	--

- ◆ Commands whose final character is "="

Each command code is sent to the balance followed by numerals (sometimes including a decimal point) and with a delimiter appended at the end.

Example 2:

ID = 1 2 3 4 (C / R)	This sets "1234" as the balance ID.
------------------------	-------------------------------------

Example 3:

UW1 = 1 . 2 3 (C / R) (Example for models with two places after the decimal point)	This sets 1.23 g as the unit weight for piece counting 1.
---	---

Example 4:

UW1 = 0 . 0 0 (C / R) (Example for models with two places after the decimal point)	This clears the unit weight for piece counting 1.
---	---

Working from the PC connected to the balance, it is possible to instruct a weighing operation or to display a numerical value of your choice at the balance.

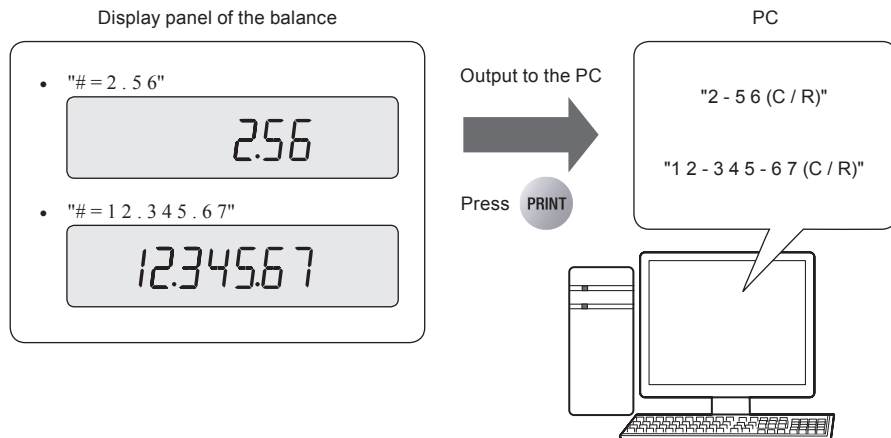



Output to the PC

In order to distinguish between instruction information from the PC and the balance's weight display data, "." is converted to "-" before output.

◆ Echo-back commands

A character string comprising N characters following an echo-back command "{" or "}" and terminated by a delimiter is resent unchanged from the balance (provided unprocessed commands do not remain in the balance's receive buffer, and $N \leq 30$).

Example 5:

A B C D E F G 1 2 3 4 5 (C / R)	After receiving this command, the balance outputs A B C D E F G 1 2 3 4 5 (C/R). When a printer is used in combination with the balance, this character string can be printed by the printer (printing of any required character string).
------------------------------------	--



To print with the printer

Only use upper case letters of the alphabet, numerals and some symbols (including the decimal point and signs), and limit the string to within 15 characters.

◆ Command list

Data output

Command	Function
D01 *2	Continuous output *1
D02 *2	Continuous output at stability
D03 *2	Continuous output with stability information
D05	Single output
D06	Auto print setting
D07	Single output with stability information
D08	Single output at stability
D09	Cancel output

*1 When handshake is OFF, output at a cycle around 100 msec.

Key operation

Command	Function
BREAK	Break key
Q	
CAL	Calibration key
TARE	Zero setting / taring key
T	
PRINT	Output key



Acceptance of commands

Depending on the status of the balance, even though a command is output it may not be accepted, with the display of "COM ERR".

*2 Not applicable to a verified balance as a legal measuring instrument.

▽ Connecting to a PC (RS-232C)

Application weighing

Command	Function	
R	Cancels application weighing mode setting	
Piece counting		
PCS□	Sets the piece counting (PCS) mode	□: 1 to 5 mode numbers
UW□ = XX.XXXXX	Sets the unit weight	XX.XXXXX : Setting value
UW□	Reads the unit weight*	
UB□ = XXX	Sets the reference number of pieces	XXX : Reference number of pieces value
UB□	Reads the reference number of pieces	
RECAL	Recalculates the unit weight	
Percentage weighing		
G	Switches between percentage (%) and gram units	
%	Sets the percentage weighing mode	
Formulation		
M	Sets the formulation mode	

* When a value that the balance cannot display has been set with command UW□, however, the value set with the command is used for calculations.

Other functions

Command	Function	
Comparator		
TRGT	Establishes the target mode	
TARGET = XX.XXXXX	Sets the target in the target mode	XX.XXXXX: Setting value
LIMIT = XX.XXXXX	Sets the target range in the target mode	
CHKW	Establishes the checkweighing mode	
OVR.RNG = XX.XXXXX	Sets the checkweighing range upper limit value in the checkweighing mode	XX.XXXXX: Setting value
UNDRNG = XX.XXXXX	Sets the checkweighing range lower limit value in the checkweighing mode	
HILIM = XX.XXXXX	Sets the pass range upper limit value in the checkweighing mode	
LO.LIM = XX.XXXXX	Sets the pass range lower limit value in the checkweighing mode	
GO	Reads the results [Response command] HL (above "too heavy" range) HI (too heavy) OK (appropriate weight, pass) LO (too light) LL (below "too light" range)	

System-related commands

Command	Function	
ID = XXXX	Sets the balance ID	XXXX: Setting value
ID	Reads the balance ID	
STATE	Outputs the setting details	

Commands relating to calibration

Command	Function	
ECAL	Starts external calibration	
ECAL.W = XXX.XXXX	Sets the reference weight value (W ref) for calibration	XXX.XXXX: Setting value
ICAL	Executes calibration with the internal weight	

Commands relating to zero / taring

Command	Function	
ZRNG = X.XXXX *1	Sets the zero range	X.XXXX: Setting value

Commands relating to unit registration

Command	Function
g	Sets gram units
mg	Sets milligram units (only accepted by models capable of displaying 0.001 g)
ct	Sets carat units
mom*1	Sets momme units

Other companies' commands

Command	Function
TI	Immediate taring (Mettler)
S	Single output at stability (Mettler)
SI*1	Immediate single output (Mettler)
SIR*1	Continuous output (Mettler)
SR*1	Continuous output at stability (Mettler)
(ESC) P	Immediate single output (Sartorius) ESC = &H1B
(ESC) T	Immediate taring (Sartorius) ESC = &H1B

Others

Command	Function	
"_" (space)	Buffer clear command	
# = XXXXXXXX	Enters and displays a numerical value	XXXXXXXX : Numerical value
{□□ ...	Echo-back mode	□□ ...: Character string

*1 Not applicable to a verified balance as a legal measuring instrument.

Connecting to a Printer

ATX/ATY series balances can be connected to the following electronic printers (available as options).

- EP-80 electronic printer
- EP-90 electronic printer



Outputting to a printer while simultaneously using the WindowsDirect communication function...

This is possible with the EP-80 and EP-90 electronic printers. For details, refer to the printer instruction manuals.

When using a printer, connect it to the balance by following the procedure below.

- 1** Turn off the power to the balance and the printer.
- 2** Using the cable supplied as an accessory with the printer, securely connect the DATA I/O connector at the balance and the connector at the printer.
- 3** Turn on the power to the balance.
- 4** Turn on the power to the printer.



What to do if...

- ◆ When turning the power off, turn off the power to the printer first, then the power to the balance.
- ◆ For more information on the printer, see the printer instruction manual.



When the GLP output function ( page 135) is on, the statistic calculation function of the printer cannot be used.

Communication Settings

This section explains the menu settings that determine the communication specifications when the balance is connected to a PC, printer, or other device.

For information on the WindowsDirect communication function, see "WindowsDirect Communication Function" (👉 page 105).

The settings made here are effective simultaneously for RS-232C and the DATA I/O communication ports. If you are connecting the printer to the DATA I/O connector, set the communication specifications of the balance to "MODE1".

The default setting is "MODE1".

Apart from this default setting, another five modes comprising frequently used combinations of communication settings are provided.

Selecting one of the settings from "MODE1" to "MODE5" allows you to set all of the following items at once: baud rate (communication speed), parity (bit length), stop bit, handshake, data format, delimiter.
👉 "Standard Settings (MODE)", page 120

The user can set each item according to requirements.
👉 "User-Specified Settings", page 120

	WindowsDirect Communication	Standard Settings 1	Standard Settings 2	Standard Settings 3	Standard Settings 4	Standard Settings 5	User-Specified Settings
Display with user-specified settings	WINI etc.	MODE.1	MODE.2	MODE.3	MODE.4	MODE.5	MODE.U
Relevant manufacturer	Shimadzu	Shimadzu (standard)	Shimadzu (responses given*)	Mettler	Sartorius	A&D	-
Baud rate (communication speed)	300	1200	1200	2400	1200	2400	Any required setting
Parity (bit length)	None (8)	None (8)	None (8)	Even (7)	Odd (7)	Even (7)	Any required setting
Stop bit	1	1	1	2	2	2	Any required setting
Handshake	Hardware	Hardware	Hardware	OFF	Hardware	OFF	Any required setting
Data format	WindowsDirect communication	Shimadzu standard	Shimadzu standard	Mettler standard	Sartorius standard	A&D standard	Any required setting
Delimiter	WindowsDirect communication	C/R	C/R	C/R+L/F	C/R+L/F	C/R+L/F	Any required setting

* The balance can return responses to commands from a PC.
When a command is received normally, OK (C/R) is returned and when a command is received abnormally, NG (C/R) is returned.

▽ Communication Settings

■ Standard Settings (MODE)

Make a selection from the setting combinations "MODE1" to "MODE5".

- 1 Press **PRINT** for about 3 seconds in the weighing mode.

This opens the output menu.

- 2 Select communication setting.

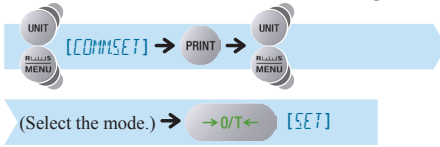

- When "MODE2" is selected

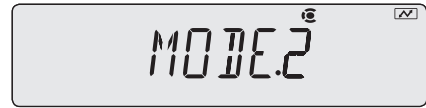

- 3 Return to the weighing mode.



■ User-Specified Settings

In this setting each of the communication settings can be set according to the user's requirements.

- 1 Press **PRINT** for about 3 seconds in the weighing mode.

This opens the output menu.

- 2 Select user-specified setting.

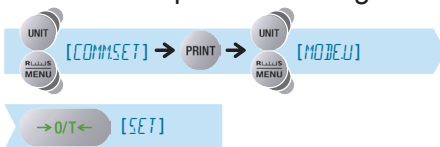

3 Make the communication settings according to your own requirements.

Set the following items as necessary.

Setting the baud rate (communication speed)

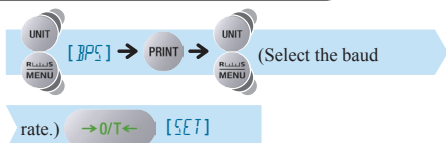

Indication	B.300	B.600	B.1200	B.2400	B.4800	B.9600	B.19.2k	B.38.4k
Baud rate	300 bps	600 bps	1200 bps	2400 bps	4800 bps	9600 bps	19.2k bps	38.4k bps

Setting the parity (bit length)

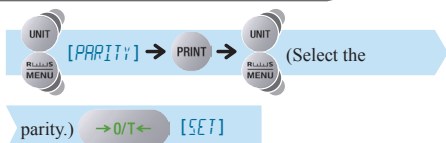

Indication	P.NONE	P.ODD	P.EVEN
Parity (bit length)	No parity, 8-bit length	Odd parity, 7-bit length	Even parity, 7-bit length

Setting the stop bit

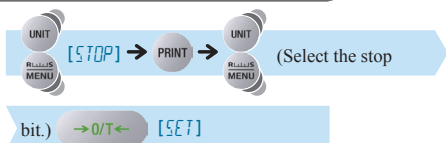

Indication	S. 1	S. 2
Stop bit	Stop bit = 1 bit	Stop bit = 2 bits

Setting the handshake

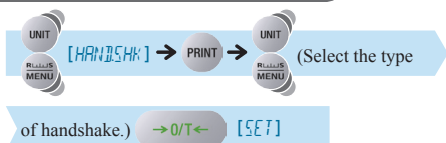

Indication	H5.OFF	H5.HW	H5.SW	H5.TIM
Handshake	No handshake	Hardware handshake	Software handshake	Timer handshake

▽ Communication Settings



What to do if...

The default setting is "hardware handshake".

- ◆ When connecting to a printer, select "hardware handshake".
- ◆ When connecting to a PC, select "no handshake".

Setting the data format

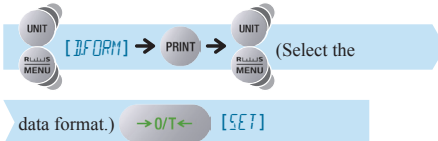

Indication	DF.1	DF.2	DF.3	DF.4	DF.FRE
	Data format 1	Data format 2	Data format 3	Data format 4	Free format
Data format	This is Shimadzu's standard format. Normally, make this setting.	This is an expansion of the data format 1 function.	This is the same format as used by Mettler balances.S	This is the same format as used by Sartorius balances.	This is a format that allows the leading bytes and number of send data to be set freely. The leading bytes can be set in the range 1 to 17 and the number of send data can be set in the range 8 to 23.

Setting a delimiter

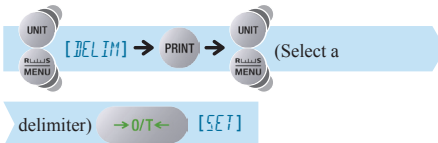

Delimiter: A symbol used to partition individual data items and individual commands

Indication	CR	LF	CR+LF	COMMA	WIN-WIN-U
Delimiter	CR	LF	CR+LF	Comma	WindowsDirect communication *

* Batch set all of the communication settings for the WindowsDirect communication function by following the procedure in "Setting the Function" (page 105).

4 Return to the weighing mode.



Output Timing Change Function

Data can be set to output without waiting for detection of stability (immediate output), or to output only after detecting stability (output after stability), when **PRINT** is pressed.



Not applicable to a verified balance as a legal measuring instrument.

- 1 Press **PRINT**  for about 3 seconds in the weighing mode.

This opens the output menu.

- 2 Select the output timing change function.

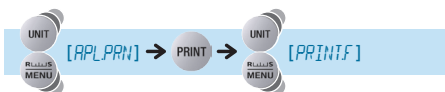

Stability Mark	Output Timing Change Function
Lit	When "immediate output" is set
Unlit	When "output after stability" is set



Check the presence or absence of the stability mark.

- 3 Change the setting.

Pressing **→O/T←** alternately selects "immediate output" and "output after stability".



When "immediate output" is set, the stability mark is lit.

- 4 Return to the weighing mode.



11 MAINTENANCE

Maintaining the Balance

⚠ Caution



Instructions

Before starting maintenance on the balance, disconnect the AC adapter from the power outlet.

If you carry out maintenance with the AC adapter left plugged into the power outlet, you may sustain an electric shock.

Main body

- Wipe over with a soft cloth moistened with a little neutral detergent and well wrung out.
- When cleaning the inside of the balance, be sure to remove the pan, pan supporter and pan rings. Take care not to touch the shaft and not to allow dusts come inside from holes around the shaft.

Pan

When cleaning the pan, be sure remove it from the body. The pan can be washed with water. In that case, dry it thoroughly before fitting it back on the balance.



Display

Avoid using organic solvents, chemical agents or cloths impregnated with chemicals since they will damage the coating of the balance and the display panel.

If the balance is used in an environment where it gets dirty easily, use the protective in-use cover available.

Glass door

The door can be removed and the door rails can be wiped over or replaced.

For details on how to remove the door, see "Removing the Glass Door" (📖 page 125).

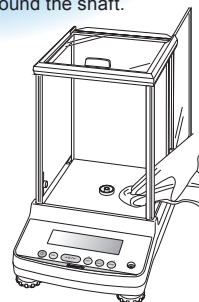
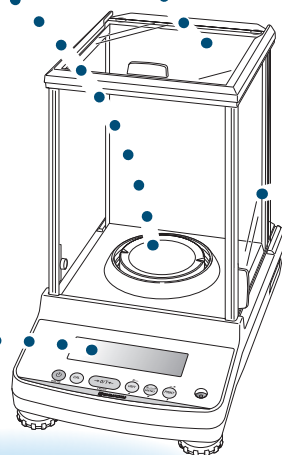

Removing the Glass Door

The glass door of the ATX ATY series of balances can be removed to clean the door rails.

! Caution



Instructions

Handle the glass door with due care.

- Take care when handling the glass door so as not to crack it.
- Take care not to injure your hands on the door rail.
- Exercise due care when handling broken glass.

1 Remove the pan and pan supporter.

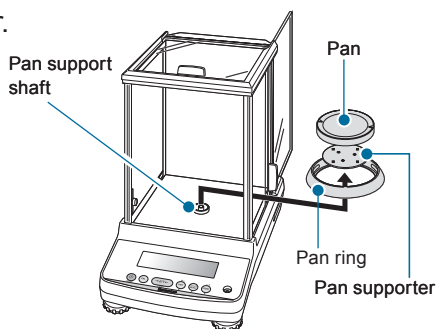

2 Turn the knob on the inner side of the handle to remove the handle.

! Caution



Prohibitions

Do not touch the pan support shaft.

This could damage the balance.

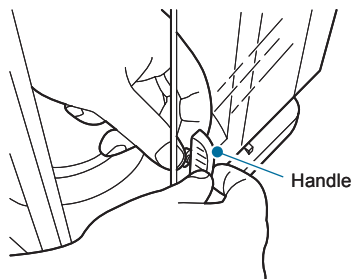

3 Pull the glass door out from the rear.

4 Install the glass door with steps in the reverse order when it is removed.

! Caution



Instructions

When fitting the glass door, be sure to fit the knob.

If you forget to fit the knob the glass door could fall off.

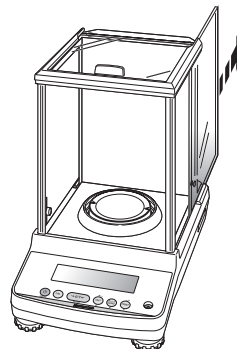

Inspection

Since the balance may develop error due to its application and environment of use, it must undergo both daily and periodic inspections in order to properly maintain its required performance and functions.

However, since the management standards governing the content of these inspections (methods, judgment criteria, etc.) will differ depending on the purpose of use, management goals, they must be determined by the customer.

If the content of the inspections is made too lax, the risk that you will continue to use the balance without discovering an abnormality increases, but if it is excessively strict it may reduce working efficiency, so you should take the care to devise balanced inspection content, considering the risks, the performance that is required in the work to be done.

This section indicates the guidelines for daily inspections and periodic inspections.

Please use these guidelines for reference when deciding the practical details of your own inspections.

Daily Inspections

Daily inspections are inspections performed on a daily basis (for example before starting work) by the person who actually uses (or manages) the balance.

The points inspected in daily inspections can, if you like, be reduced to the minimum necessary.

Here are some examples for your reference.

	Daily Inspection [Reference Example 1]	Daily Inspection [Reference Example 2]
Frequency of inspection	Once per day	Once to several times per day (as required)
Inspection timing	Before the start of work	Before the start of work and when performing important weighing operations
Method of inspection	Observe the instrumental error at a single point. Set the "observation point" as a point a little above the upper limit value of the range in which the balance is actually used to weigh.	Observe the instrumental error at a single point. As the point to be observed before the start of work, set a point a little above the upper limit value of the range in which it is possible that actual measurements will be made.
Criterion of judgment	To be accurate to within ± 5 at one decimal place to the right of the digit where accuracy is required when actually weighing with the balance.	To be accurate to within ± 5 at one decimal place to the right of the digit where accuracy is required when actually weighing with the balance.



What is instrumental error?

This is the amount of the discrepancy between the value indicated by the balance and the correct value.

It is assessed as the difference between the weight reading when a weight that corresponds to the observation point is weighed on the balance and the actual weight value of that weight.

For details on weights, see "About Weights" (🔗 page 128).

Periodic Inspections

Periodic inspections are inspections that are performed periodically (for example once a year). The content of periodic inspections must cover all aspects including performance and functions.

An overview is given below.

Overview of Periodic Inspection [Reference Example]	
Frequency of inspection	Once a year
Inspection timing	Any day during the established month
Method of inspection	<p>Check for abnormalities in the following functions and external appearance.</p> <ul style="list-style-type: none"> • Display panel • Menu operation keys / operation keys • Pan • Level <p>Check the following aspects of performance.</p> <ul style="list-style-type: none"> • Repeatability: Weigh a weight that corresponds to approximately half of the weighing capacity of the balance five to ten times and assess the dispersion in the weight readings obtained. • Eccentric error: Assess the difference in the weight readings obtained when a weight corresponding to one fourth to one third of the weighing capacity of the balance is placed in the center of the pan and at a position shifted from the center by a specified distance. • Instrumental error: Decide on three to five observation points and assess the difference between the values obtained when weights corresponding to these points are weighed on the balance and the actual weight values of the weights.
Criterion of judgment	To be accurate to within ± 5 at one decimal place to the right of the digit where accuracy is required when actually weighing with the balance.

For details on weights, see "About Weights" ( page 128).

About Weights

In order to establish and maintain the performance of the balance, weights must be used to accurately adjust the balance's scale, and to check its adjustment.

With the ATX/ATY series balances, weights are used when performing a part of calibration (👉 page 48) and inspections (👉 page 126) in the environment in which the balance is actually used. The weights should be prepared in advance and managed properly.

Types of Weight and Their Selection

There are many types of weights.

Select the appropriate weights for the specifications of your balance by referring to the following table.

◆ Selecting the class of weight

As the main form of classification, weights are normally divided into classes according to their degree of accuracy.

Select the most appropriate class of weights to be used for calibration and inspection of the balance, based on the type of the balance.

The table below shows the classes of weight and the applicable balances.

Select weights whose Class of Weight is E2.

Class of Weight	Applicable Type of Balance		
	Minimum Indication	Resolution*	Common Name
E2	Less than 1 mg	Around 1/1,000,000 or better	Analytical balances
F1	1 mg or greater	Around 1/100,000 or better	Toploading balances
F2	1 mg or greater	Around 1/100,000 or lower	Toploading balances
M1	10 mg or greater	Around 1/10,000 or better	Scales, etc.

* "Resolution" means: minimum indication / weighing capacity

◆ **Selecting the calibration weights to be used**

Now you must select the "indicated weight" of the weight to be used (how many grams it should be).

The weights of weights are set with the smallest at 1 mg and progressing in the sequence 1 mg, 2 mg, 5 mg, ... as shown below.

1 mg, 2 mg, 5 mg, 10 mg ... 1 g, 2 g, 5 g, 10 g, 20 g, 50 g, 100 g ...

When selecting a weight to be used for calibrating a balance, you are recommended to select one that is close to the weighing capacity of the balance.

The table below shows the recommended calibration weights to be used for balances with different weighing capacities.

Weighing Capacity of Balance	Recommended Weight of Weight for Calibration
62 g	60 g (50 g + 10 g)
82 g	80 g (50g + 20g +10g)
124 g	100 g
220 g	200 g

For information on the range of weights that can be used to calibrate balances (i.e. values that can be entered as the weight value) see "Calibration range with external weights" (📖 page 138) in "Specifications".

It is also possible to calibrate a balance with a weight that is not close to the weighing capacity of the balance.







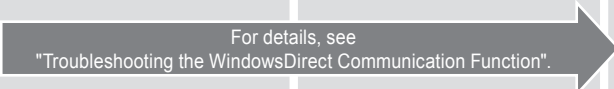



However, if you do this, when weighing in the range that exceeds the weight value that was used for calibration, the performance may deteriorate proportionately (the instrumental error may become larger).

12 TROUBLESHOOTING

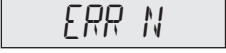
What to Do If....

Symptom	Probable Cause(s)	Countermeasure	See:
Nothing is displayed on the display panel.	<ul style="list-style-type: none"> ● The power cable is disconnected. ● The main switch on the distribution panel is off. ● The power supply voltage is wrong. 	<ul style="list-style-type: none"> ● Check the power supply and voltage and make the connections correctly. 	Page 138
The display doesn't change when a sample (item to be weighed) is placed on the pan.	<ul style="list-style-type: none"> ● The pan has been displaced. 	<ul style="list-style-type: none"> ● Set the pan correctly on the balance. 	Page 24
The display fluctuates and → (the stability mark) does not appear readily.	<ul style="list-style-type: none"> ● The balance has been installed in an unstable environment. 	<ul style="list-style-type: none"> ● Eliminate the effects of vibration and air movement. ● Install the balance on a robust platform. 	Page 22
	<ul style="list-style-type: none"> ● Check if the object for weighing sticks out of the pan. 	<ul style="list-style-type: none"> ● Place the object so it does not stick out too much of the pan. 	—
	<ul style="list-style-type: none"> ● Check if anything other than the object for weighing touches the pan. 	<ul style="list-style-type: none"> ● Avoid anything other than the object for weighing touching the pan. 	—
The weighing result is not accurate.	<ul style="list-style-type: none"> ● The glass door of the windbreak is open. 	<ul style="list-style-type: none"> ● Close all the glass doors before reading the display. 	—
	<ul style="list-style-type: none"> ● Span calibration has not been performed. ● Is the display at zero before weighing? 	<ul style="list-style-type: none"> ● Perform span calibration. ● Press →0/T← to set the display at zero before weighing. 	Page 52 Page 32
The units that you want to use are not displayed.	<ul style="list-style-type: none"> ● The units that you want to use have not been set. 	<ul style="list-style-type: none"> ● Set the units that you want to use for . 	Page 77
Menu operations are not possible.	<ul style="list-style-type: none"> ● Menu operation is locked. 	<ul style="list-style-type: none"> ● Release the menu lock. 	Page 46
The WindowsDirect communication function cannot be used.	<div style="text-align: center;"> <p>For details, see "Troubleshooting the WindowsDirect Communication Function".</p>  </div>		Page 110
Calibration (I.GAL) by using internal weight takes longer than usual.	<ul style="list-style-type: none"> ● If END is displayed after waiting for a while, it does not mean any abnormalities; use as usual. 		Page 48

Responding to Messages

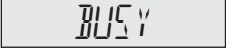
Message Display	Probable Cause(s)	Countermeasure	See:
 (Hardware error)	<ul style="list-style-type: none"> There is a fault in the hardware, such as the temperature sensor or internal weight mechanism (TW series only). There is an error in the internal system data. 	<ul style="list-style-type: none"> Disconnect the AC adaptor and turn the power back ON. If the same message is still displayed, contact your Shimadzu representative. 	Page 26
 (Span calibration error)	<ul style="list-style-type: none"> The balance has a large drift of the zero point or sensitivity. A container is placed on the pan. The pan is displaced. The wrong weight has been placed on the pan. 	<ul style="list-style-type: none"> Press  to return to the weighing mode. Execute span calibration again in an appropriate condition. 	Page 48
 (CAL D)	<ul style="list-style-type: none"> Display is very instable. 	<ul style="list-style-type: none"> Press  to return to the weighing mode and execute calibration again when there is no wind or vibration. If CAL D is still displayed, contact your Shimadzu representative. 	Page 48
 (Numerical value entry error)	<ul style="list-style-type: none"> Either a mistake has been made when entering the value or the value is not appropriate. 	<ul style="list-style-type: none"> After the error is displayed, the balance returns to the status immediately before the error occurred. Enter the correct numerical value. 	Page 43
 (Operation error)	<ul style="list-style-type: none"> The operation used is wrong. 	<ul style="list-style-type: none"> After the error is displayed, the balance returns to the status immediately before the error occurred. At this point, follow the correct operation. 	—
 (External input error)	<ul style="list-style-type: none"> An unrecognizable command code has been received. 	<ul style="list-style-type: none"> After the error is displayed, the balance returns to the status immediately before the error occurred. At this point, set the correct command code. 	Page 114
 (overload)	<ul style="list-style-type: none"> Either the pan or the pan supporter is displaced. 	<ul style="list-style-type: none"> Set the pan or pan supporter correctly on the balance. 	Page 24
 (overload)	<ul style="list-style-type: none"> The weighing capacity has been exceeded. 	<ul style="list-style-type: none"> Use the balance within its weighing capacity. 	Page 138
 (Operation aborted)	<ul style="list-style-type: none"> The calibration or standard value setting operation has been aborted. 	<ul style="list-style-type: none"> After this is displayed, the balance returns to the operable state. 	—
 (Waiting for permission for the operation)	<ul style="list-style-type: none"> This message is displayed in order to avoid unnecessary key operations. 	<ul style="list-style-type: none"> After this is displayed, the balance returns to the operable state. 	—
 (Load detected)	<ul style="list-style-type: none"> There was something placed on the pan when calibration was started. 	<ul style="list-style-type: none"> Take the item off the pan. The message will be cleared automatically and you will be able to continue calibration. 	Page 52

13 FOR YOUR INFORMATION

Turning the Power ON and OFF

Auto Power-Off Function

When the auto power-off function is turned on, the liquid crystal display will go fully off automatically (to the standby mode) if there is no weighing or key operation during the set time.

- 1 Press **RECALL MENU** twice in the weighing mode.

This opens the main menu.

- 2 Select the auto power-OFF function.

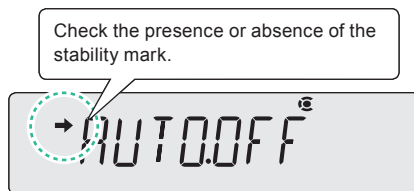
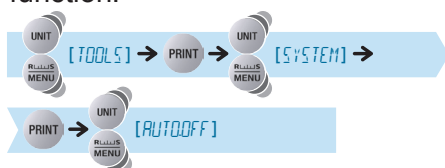

What is the current situation?

Stability Mark	Auto Power-Off Function
Lit	ON
Unlit	OFF

What do you want to do?

To Set / Update	To Cancel
Press PRINT and go to step 3.	Press →0/T← and go to step 4.
Press →0/T← and go to step 3.	Go to step 4.

- 3 Enter the time (in minutes).

(Enter the time (in minutes).) → **→0/T←** [SET]

"Entering Numerical Values", page 43

Setting time for auto power-off function

The upper limit time which can be set for the auto power-off function is 99 minutes.



- 4 Return to the weighing mode.

POWER or **ON/OFF** 3 sec.

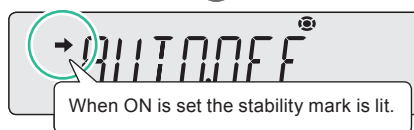

Setting the Startup Display

Select the startup display from one of the three following types.

Weighing mode	After the power is turned on, the balance proceeds automatically to the weighing mode.
OFF display	After the power is turned on, the balance stops with the "OFF display". When any of the keys is pressed during the OFF display the balance automatically proceeds to the all segments lit display and then to the weighing mode.
All segments lit	After the power is turned on, the balance stops with the "OFF display". When any of the keys is pressed during the OFF display, the balance stops with all display segments lit. Pressing  while all segments are lit takes you to the weighing mode.

1 Press  twice in the weighing mode.

This opens the main menu.

2 Select setting of the startup display.

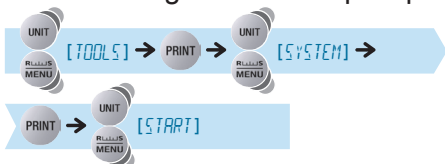

START^o

3 Select the type of startup display.

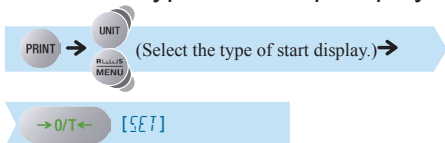

- Weighing mode

AUTO^o

- OFF display

SEMAUTO^o

- All segments lit

MANU^o

➔ (the stability mark) lights up for the set start display.

4 Return to the weighing mode.



The startup display is now set.

Changing the Password

To execute menu reset (☞ page 45), to set or cancel menu lock (☞ page 46), or to execute calibration of the internal weight (☞ page 46), you have to input a password.

"9999" is set as the default password, but this can be changed by following the procedure below.

- 1** Press  twice in the weighing mode.

This opens the main menu.

- 2** Select the password.

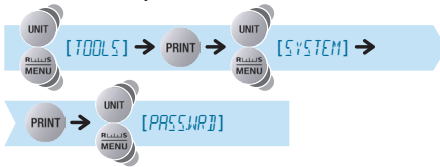

- 3** Enter the current password.

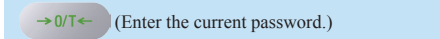

- 4** Enter the new password.

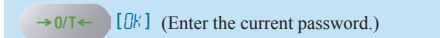

 "Entering Numerical Values", page 43



- 5** Confirm.

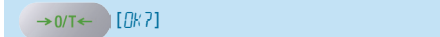

To cancel at this point, press . The balance will return to the status after step 2, without setting the value entered in step 3.

To confirm the password, proceed as follows.



- 6** Return to the weighing mode.



GLP Output Function

On turning the GLP output function ON, you can add the balance ID and other information to the calibration record (👉 page 59) and weight reading outputs. However, the statistic calculation function of the printer cannot be used.

Example printout from printer
(When the GLP output function is set to ON)

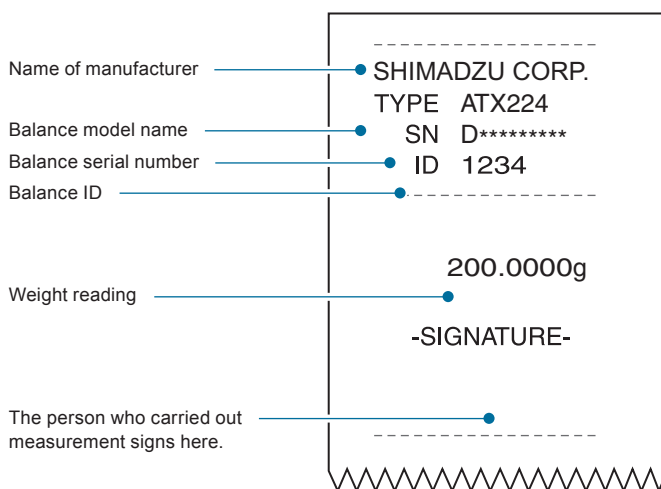

Setting the GLP Output Function

1 Press **CAL** for about 3 seconds.

This opens the calibration menu.

2 Select the GLP output function.

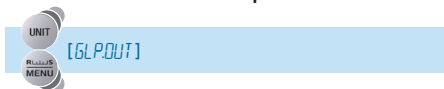

Stability Mark	GLP Output Function
Lit	ON
Unlit	OFF

Check the presence or absence of the stability mark.



▽ GLP Output Function

3 Change the setting.

Pressing /T alternately sets the ON and OFF settings.

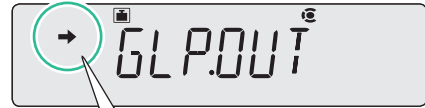

When ON is set the stability mark is lit.

4 Return to the weighing mode.



 On setting the GLP output function to ON and outputting weight readings...

A long time is required to output one weight reading. In addition, depending on conditions, data may not be printed correctly at the printer. See the setting conditions below.

Handshake Settings in the Communication Settings (📖 page 117)	Rough Time Required for Output of One Weight Reading		
	Printer Only	PC Only	Both Printer and PC used
OFF	Nonprintable	Approx. 3 sec.	Correct printing is not possible
SW (software)	Nonprintable	Approx. 3 sec.	Correct printing is not possible
HW (hardware)	Approx. 10 sec.	Approx. 10 sec.	Approx. 10 sec.
TIM (timer)	Approx. 35 sec.	Approx. 35 sec.	Approx. 60 sec.

 On setting the GLP output function to ON and using the command code "D01 (continuous output)"...

No items other than weight readings are output.

Setting a Balance ID

When managing multiple balances, by setting a four-digit management number (ID) and turning the GLP output function ON, you can add the balance ID to calibration records (👉 page 67) and weight reading outputs.

- 1 Press  twice in the weighing mode.

This opens the main menu.

- 2 Select setting of a balance ID.

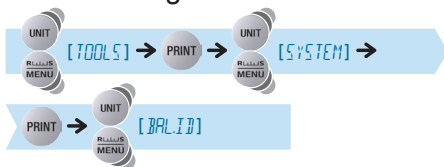

- 3 Enter the required numerals (max. 4 digits).

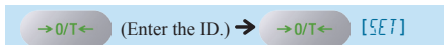

👉 "Entering Numerical Values", page 43

The default ID is "0000".



- 4 Return to the weighing mode.



Specifications

ATX/ATY Series

Model Name	ATX224	ATX124	ATX84	ATY224	ATY124	ATY64
Weighing capacity	220 g	120 g	82 g	220 g	120 g	62 g
Minimum indication	0.1 mg	0.1 mg	0.1 mg	0.1 mg	0.1 mg	0.1 mg
Range of external weights for calibration	95 - 220 g	45 - 120 g	45 - 82 g	95 - 220 g	45 - 120 g	45 - 62 g
Repeatability (standard deviation)	≤ 0.1 mg					
Linearity	± 0.2 mg					
Response time *1	Approx. 3.0 seconds					
Operating temperature and humidity limits	5 - 40 °C 20~85% *2					
Temperature coefficient for sensitivity (10 - 30 °C)	± 2 ppm/°C					
Pan size (mm)	Approx. φ 91 *3					
Main body dimensions (mm)	Approx. 210 (W) × 340 (D) × 325 (H)					
Main body weight	ATX: approx. 6.2 kg ATY: approx. 6.0 kg					
Display	LCD					
Rated electric power supply	DC 12 V, 1 A					
I/O terminal	DATA I/O					
Pollution Degree	2					
Overvoltage Category	Category II					
Altitude	Up to 2000 m					
Installation Site	device may only used indoors					
AC adapter (primary)	AC 100- 240 V, 400 mA 50/60 Hz					

*1 The response time is a representative value.

*2 No condensation

*3 The size of the pan is the dimension of outer diameter.

* The part numbers, specifications, etc. indicated here are subject to change without notice.

Verified Balance as a legal measuring instrument

Model Name		ATX224	ATX124	ATX84	ATY224	ATY124	ATY64
g	Accuracy class	I					
	Capacity	220 g	120 g	82 g	220 g	120 g	62 g
	Verification scale interval (e)	0.001 g					
	Number of verification scale interval	220000	120000	82000	220000	120000	62000
	Scale interval (d)	0.0001 g					
	Range of use	0.01 g - 220 g	0.01 g - 120 g	0.01 g - 82 g	0.01 g - 220 g	0.01 g - 120 g	0.01 g - 62 g
ct	Accuracy class	I		/	I		/
	Capacity	1100 ct	600 ct		1100 ct	600 ct	
	Verification scale interval (e)	0.01 ct			0.01 ct		
	Number of verification scale interval	110000	60000		110000	60000	
	Scale interval (d)	0.001 ct			0.001 ct		
	Range of use	0.1 ct - 1100 ct	0.1 ct - 600 ct		0.1 ct - 1100 ct	0.1 ct - 600 ct	
Response time *1		Approx. 3.0 seconds					
Ambient operating temperature		10–30 °C					
Pan size (mm)		Approx. ϕ 91 *2					
Main body dimensions (mm)		Approx. 210(W) X 340(D) X 325(H)					
Main body weight		ATX : Approx. 6.2kg ATY : Approx. 6.0kg					
Display		LCD					
Rated electric power supply		DC 12 V, 1 A					
I/O terminal		DATA I/O					
Pollution Degree		2					
Overvoltage Category		Category II					
Altitude		Up to 2000 m					
Installation Site		device may only used indoors					
AC adapter (primary)		AC 100- 240 V, 400 mA 50/60 Hz					

*1 The response time is a representative value.

*2 The size of the pan is the dimension of outer diameter.

Maintenance Parts

ATX/ATY Series

◆ Maintenance parts list

Item name	Part Number (P/N)	Remarks
Pan	321-71052	
Pan supporter	321-71284	With 4 rubber parts
Pan ring	321-71053-01	
AC adaptor	321-62349	
Horizontal adjustment stands	321-71069	
Glass door left ASSY	321-71043-01	
Glass door right ASSY	321-71043-02	
Glass door upper ASSY	321-71041	
Front glass	321-62931-01	
Knobs for glass doors	321-62787-01	
Set of 4 rubber parts for pan supporters	321-62984-02	
Instruction Manual	321-78001	

◆ Optional List of special accessories (option)

Item name	Part Number (P/N)	Part Number for RoHS (P/N)	Remarks
Electronic Printer EP-80	321-62675-01 (w/o AC adapter)	321-80016-01 (w/o AC adapter)	
Electronic Printer EP-90	321-62675-11 (w/o AC adapter)	321-80016-11 (w/o AC adapter)	
RS-232C Interface IFB-102A-UNC	321-41167-20		
RS-232C Cable 25P-9P	321-60754-01		<ul style="list-style-type: none"> • RS-232C Interface (321-41167-20) is separately required.
USB - Serial Conversion Kit	321-62520-01		<ul style="list-style-type: none"> • Cable (321-60754-01) attached • RS-232C Interface (321-41167-20) is separately required.
Protective Cover (5 pcs.)	321-71026		
STABLO-EX	321-73000-01		

BEFORE WEIGHING

USING THE BALANCE

USING MORE CONVENIENTLY

MAINTENANCE

TROUBLESHOOTING

FOR YOUR INFORMATION

List of Functions That Can Be Used in Combination

A correspondence table for application functions, comparator functions and output functions is shown below. It shows whether functions can be used in combination with each other or not.

		Application Function Mode			Comparator		Output Functions				
		Piece Counting	Percentage Weighing	Formulation	Target Mode	Checkweighing Mode	WindowsDirect Communication Function	Continuous Output	Auto Print	Output Timing Change Function	GLP output function
Application Function Mode	Piece Counting		×	×	○	○	○	△	○	○	○
	Percentage Weighing	×		×	○	○	○	△	○	○	○
	Formulation	×	×		○	○	○	×	×	×	○
Comparator	Target Mode	○	○	○		×	○	○	○	○	○
	Checkweighing Mode	○	○	○	×		○	○	○	○	○
Output Functions	WindowsDirect Communication Function	○	○	○	○	○		×	○	○	○
	Continuous Output	△	△	×	○	○	×		×	×	*
	Auto Print	○	○	×	○	○	○	×		×	○
	Output Timing Change Function	○	○	×	○	○	○	×	×		○
	GLP output function	○	○	○	○	○	○	*	○	○	

See:	Page 79	Page 84	Page 88	Page 94	Page 96	Page 103	Page 100	Page 98	Page 121	Page 133
------	---------	---------	---------	---------	---------	----------	----------	---------	----------	----------









- : Can be used in combination
- △ : Can be used in combination while the weight value is displayed
- ×
- * : Weight readings are output, but no other information is output.

Menu Map

The menu map represents the organization of the menu options graphically to make it easy to understand. It is useful for quickly accessing the menu option you want to use.

For details on the organization of the menu settings and the method of operation of the menu, see "3. MENU SETTINGS" ( page 40).

Reading the Menu Map

Conventions Used in the Menu Map	Explanation of Operation
	Press  or  to search for the menu option.
	Press  to proceed to the next menu option.
	Press  to confirm.
	Press  to return to the previous menu option.
	Refers to a page in the instruction manual.
*	The default settings (settings when the menu is reset)

Main Menu

Press  twice in the weighing mode.

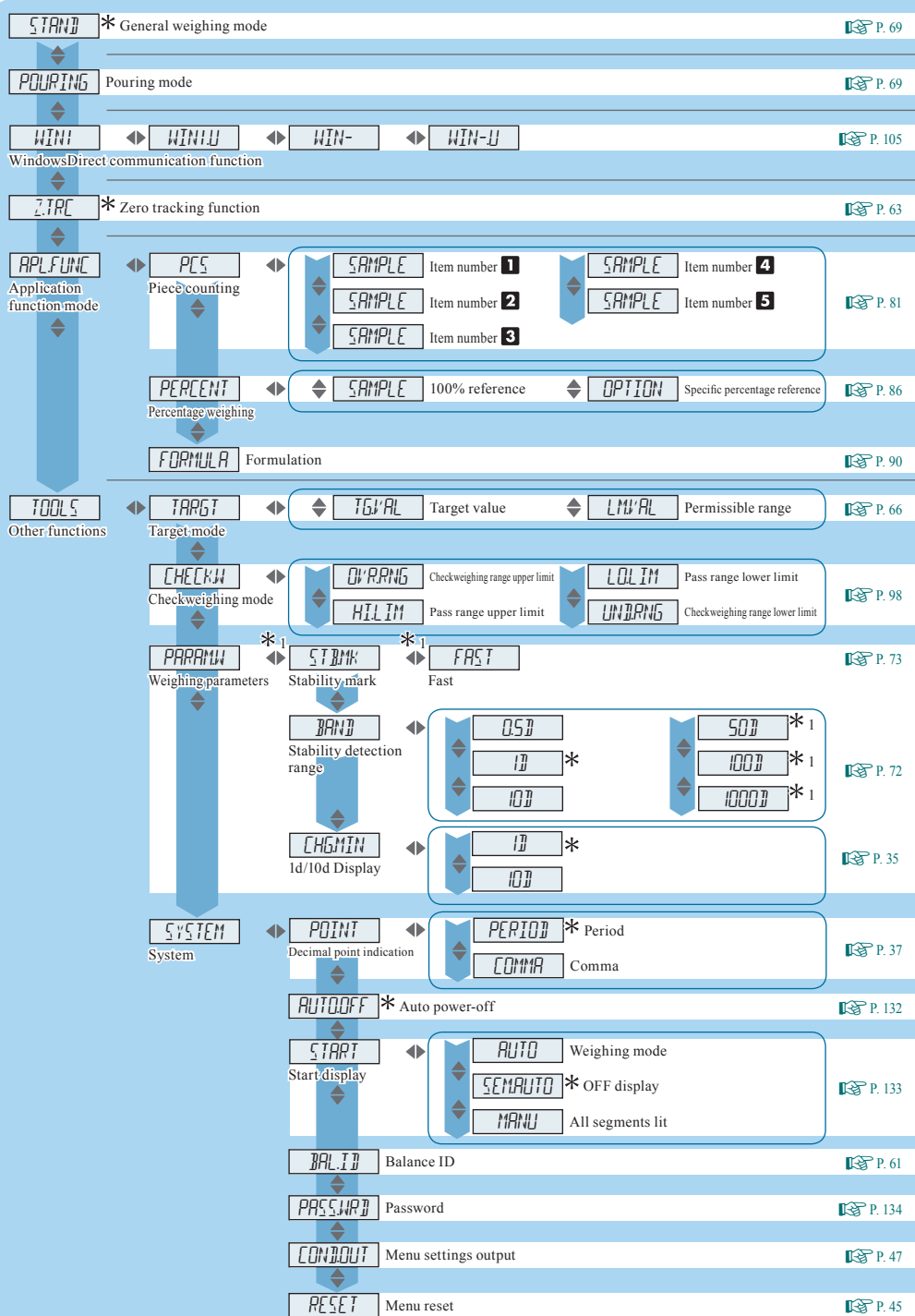

* 1 Not applicable to a verified balance as a legal measuring instrument.

Data Output Menu

Press **PRINT**  for about 3 seconds in the weighing mode.

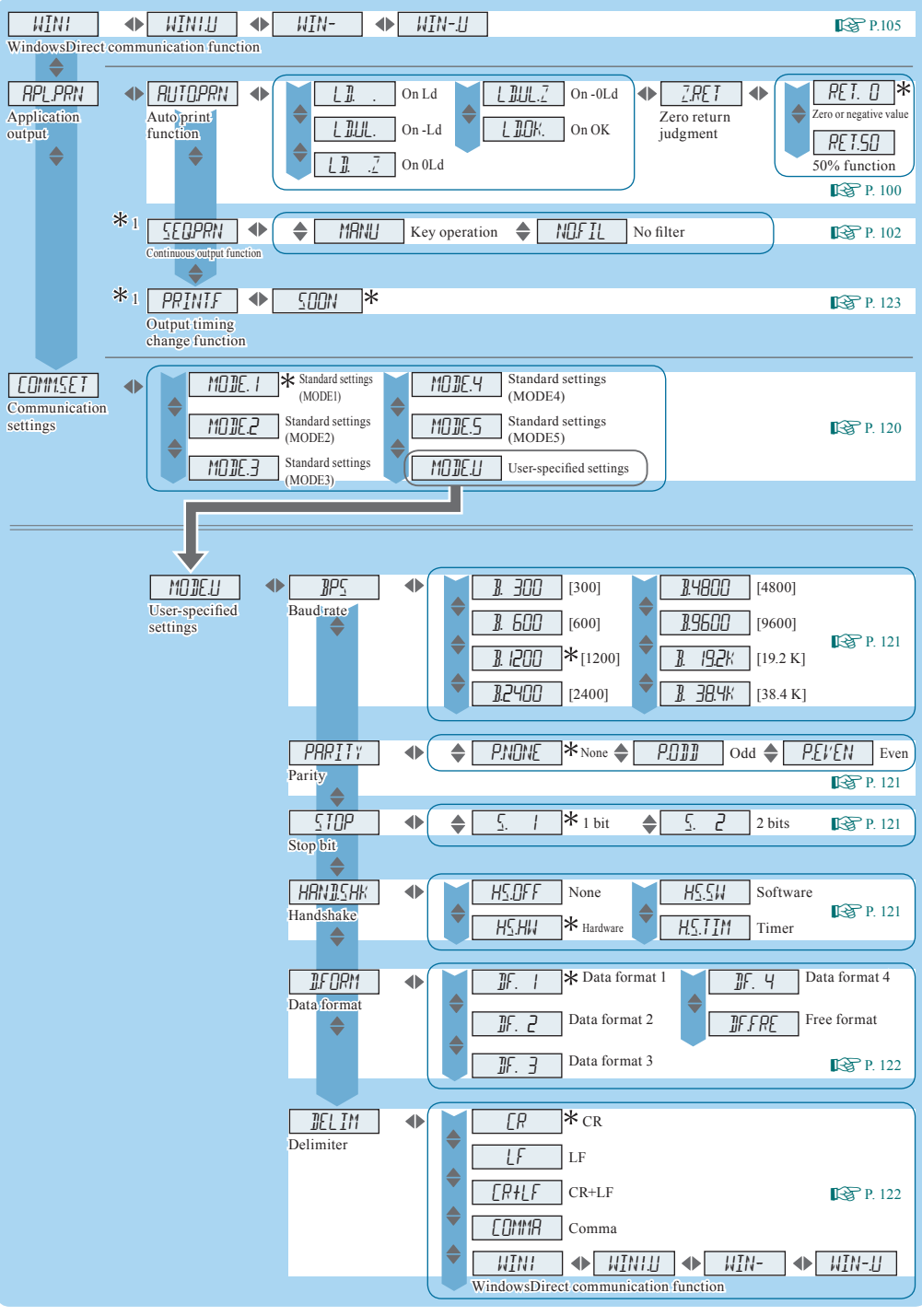

BEFORE WEIGHING

USING THE BALANCE

USING MORE CONVENIENTLY

MAINTENANCE

TROUBLESHOOTING

FOR YOUR INFORMATION

* 1 Not applicable to a verified balance as a legal measuring instrument.

▽ Menu Map

Unit Setting Menu

Press **UNIT**  for about 3 seconds in the weighing mode.

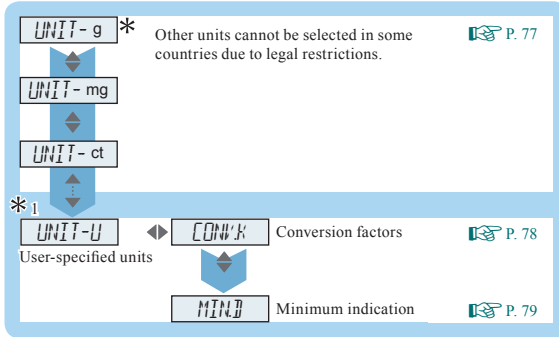

Calibration Menu

Press **CAL**  for about 3 seconds in the weighing mode.

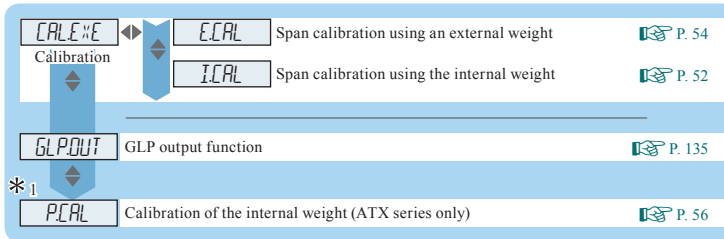

Zero / Tare Menu

Press **→0/T←**  for about 3 seconds in the weighing mode.

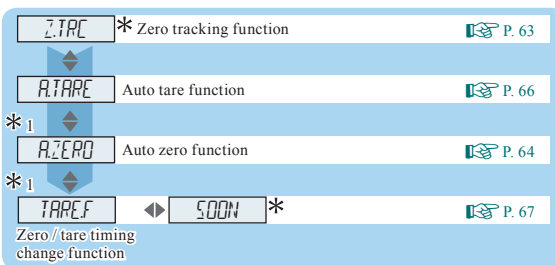

* 1 Not applicable to a verified balance as a legal measuring instrument.

MEMO

BEFORE
WEIGHING

USING THE
BALANCE

USING MORE CONVENIENTLY

MAINTENANCE

TROUBLESHOOTING

FOR YOUR
INFORMATION



Index

Symbol

- OL131

Number

100% reference 86

Alphabets

A

Adjusting the level. 24
All segments lit133
Application function mode 80
Automatic calibration symbol 20
Auto power-off function132
Auto print symbol20, 102
Auto tare function 66
Auto zero function..... 64

B

Baht76
Balance ID.....61
Battery symbol 20
Baud rate121

C

Calibration menu40, 41, 146
Calibration of the internal weight 56
Calibration record 59
Carat.76
Checkweighing mode 98
Checkweighing range lower limit value .. 98
Checkweighing range upper limit value .. 98
Command114

Communication settings119
Communication symbol 20
Comparator function 96
Comparator symbol 20, 96
Component number 93
Container32
Continuous output function.....102
Conversion factor.....76

D

Daily inspections.....126
Data format112
DATA I/O connector18
Data output menu40, 145
DC IN connector18
Decimal point display symbol.....37
Default settings45
Delimiter 122
Display panel18, 20

E

Easy setting indicator20, 71
Echo-back115
Entering numerical values.....43
ERR131
Error.....131

F

Formulation 90
Formulation symbol 20, 90

G

General weighing mode..... 69
Glass door 124

GLP output function	60, 135
Grain	76
Gram	76
Gross weight	20
Gross weight symbol	20, 91

H

Handshake	121
Hierarchical menu levels	40
Hold symbol	20
Hong Kong tael	76

I

Installation site	22
Inverse triangle symbol	20, 44
Item number	84
Item number indication	20, 84

K

Kyats	76
-----------------	----

L

Level	25
LOCKED	46

M

Main menu	40, 41
Maintenance parts	140
Malaysian tael	76
MENU	19
Menu group	40, 41
Menu lock	46
Menu lock symbol	20, 46
Menu map	143

Menu operation key symbol	20, 41
Menu reset	45
Mesghal	76
Miligram	76
Minimum number of displayed digit	35
Minus symbol	20
Momme	76

N

Net weight	20
Net weight symbol	20, 91
Number of pieces used for setting	82
Number symbol	20, 43
Numeric value / menu display area	19

O

OFF display	133
OL	131
Operation keys	19
Optional	141
Ounce	76
Output of menu setting information	47
Output timing	101
Output timing change function	123
Outputting the gross weight	94

P

P.CAL	56
Parity	121
Parts pound	76
Pass range lower limit value	98
Pass range upper limit value	98
Password	134
Pennyweight	76

Percentage of the reference weight	86
Percentage weighing	89
Percentage weighing symbol	21, 89
Periodic inspections	127
Piece counting mode	84
Piece counting symbol	20, 84
Position of the decimal point	44
Pouring mode	69
Pouring symbol	20, 69
Printer	118
Product label	18

R

Ready symbol	20, 39
Ready to weigh	90
Response	68

S

Sawaran	76
Selecting units to display	77
Singapore tael	76
Span calibration	52
Specific percentage reference	86
Specific percentage weighing symbol	21, 88
Stability	68
Stability detection range	72
Stability mark	20, 72
Stability mark lighting timing	73
Standby mode	39
Startup display	133
Stop bit	121
Switching units	35

T

Taiwan tael	76
Target mode	96
Target value	97
Taring	62
Tola	76
Tolerance range	97
Troy ounce	76

U

UNIT	19
Unit display area	19
Unit setting menu	40
Unit weight	81
User-specified units	78

W

Warming up	27
Weighing capacity	138
Weighing mode	32
Weight	128
Weight symbol	20
WindowsDirect communication function	105
Win symbol	20, 106

Z

Zero / tare menu	40, 41
Zero / tare timing change function	67
Zero point	62
Zero range	64
Zero return judgment	101
Zero tracking function	63
Zero tracking symbol	20, 63

MEMO

 **SHIMADZU CORPORATION****TOKYO OFFICE**

3, Kanda-Nishikicho 1-chome, Chiyoda-ku, Tokyo 101-8448, Japan
Phone: 81(3)3219-5641 Fax: 81(3)3219-5710
Cable Add.:SHIMADZU TOKYO
Overseas Telex No.: 0232-3291 (SHMDT J)

KYOTO OFFICE

1, Nishinokyo-Kuwararacho, Nakagyo-ku, Kyoto 604-8511 Japan
Phone: 81(75)823-1200 Fax: 81(75)812-3438
Cable Add.:SHIMADZU KYOTO
Overseas Telex No.: 05422-166 (SHMDS J)

SHIMADZU(CHINA)Co.,LTD. PUXI BRANCH

Block E, No. 570 West Huaihai Road, Shanghai, 200052 P. R. China
Phone: 86(21)2201-3888 Fax: 86(21)2201-3666

SHIMADZU SCIENTIFIC INSTRUMENTS INC

7102, Riverwood Drive, Columbia, Maryland 21046, USA
Phone: 1(410)381-1227 Fax: 1(410)381-1222

SHIMADZU EUROPA GmbH

Albert-Halm-Strasse 6-10, D-47269 Duisburg, F. R. Germany
Phone: 49(203)7687-0 Fax: 49(203)7666-25

SHIMADZU MIDDLE EAST & AFRICA FZE UAE HEAD OFFICE

Warehouse No. RA08UC02, Jebel Ali, Dubai, P.O. Box 262081 United Arab Emirates
Phone: 971(4)883-6668 Fax: 971(4)883-6808

SHIMADZU MIDDLE EAST & AFRICA FZE ISTANBUL BRANCH

Kosuyolu Mah., Salih Omurtak Cad., No:57
34718, Kadikoy Istanbul, Turkey
Phone: 90(216)545-8940 Fax: 90(216)545-8941

SHIMADZU (ASIA PACIFIC) PTE LTD.

79 Science Park Drive #02-01/08, Cintech IV Singapore Science Park 1 Singapore 118264
Phone: (65)6778-6280 Fax: (65)6779-2935

SHIMADZU DO BRASIL COMERCIO LTDA.

Avenida Marques de Sao Vicente, 1771-Barra Funda, CEP 01139-003, Sao Paulo, SP, Brazil
Phone: 55(11)2134-1688 Fax: 55(11)3611-1635

SHIMADZU SCIENTIFIC INSTRUMENTS (OCEANIA) PTY. LTD.

Unit F, 10-16 South Street Rydalmere N.S.W. 2116
Phone: 61(2)9684-4200 Fax: 61(2)9684-4055