

---

# CONTENTS

<b>1. Introduction</b> .....	1
<b>2. Precautions</b> .....	1
<b>3. Before Using the Product</b>	
3-1 Unpacking and Checking.....	1
3-2 Installing Components .....	1
3-3 Leveling the Scale.....	1
<b>4. Product Introduction</b>	
4-1 Specifications & General Features .....	2
4-2 Front Panel .....	3
4-2-1 LCD display.....	3
4-2-2 Keyboard.....	4
4-3 Power Supply.....	5
<b>5. Function Setting and Description of Parameter Values</b>	
5-1 Function Setting .....	5
5-2 Description of Parameter Values.....	5
<b>6. Calibration</b> .....	8
<b>7. Operation</b>	
7-1 weighing .....	9
7-2 manual tare & preset tare.....	9
7-3 check weighing.....	10
7-4 Simple Counting.....	10
7-5 Accumulation, Accumulation Display and Accumulation Clearing.....	11
7-6 Printer initialization by the indicator operation.....	12
7-7 Input commands.....	12
<b>8. Serial Interface</b>	
8-1 Diagram.....	12
<b>9. Troubleshooting and Error Message</b> .....	13
Appendix 1: printing format (Optional)	
Appendix 2: Exporting data to PC in the form of EXCEL	
Appendix 3: U.KEY Connector	

---

## 1. Introduction

This manual contains installation and operation instructions for the JWN Series weighing indicator. Please read the manual completely before installation and operation.

## 2. Precautions

- ⊙ Place the scale on a flat and stable surface.
- ⊙ Verify that the input voltage and the plug type matches the local AC power supply (Refer to Section 4-3).
- ⊙ **Warm up the scale for 15 minutes before using it for the first time.**
- ⊙ Make sure power cord **won't cause** a potential obstacle or tripping hazard.
- ⊙ Keep the scale away from EMI noise, strong wind and vibration, which might cause incorrect reading.
- ⊙ Avoid sudden temperature changes (suitable operating temperature is between **0°C~40°C.**)
- ⊙ Do not drop loads on the platform.
- ⊙ Disconnect the power supply while cleaning the scale.
- ⊙ Do not immerse the scale in water or other liquids.
- ⊙ Service should be performed by authorized personnel only.

## 3. Before Using the Product

### 3-1 Unpacking and Checking

Open the package and check the instrument for transport damage. Immediately inform your dealer if you have complaints or if parts are missing. The package should contain:

- Scale body
- **Weighing pan**
- Adaptor
- User manual

### 3-2 Installing Components

1) Before using the scale, remove the delivery protection screw (rotate counterclockwise), which located underneath the scale, and cork the plug buckle.

Note: the JWN-30K model is shipped without the shipping protection screw.

2) Cover the weighing pans on the scale body properly.

### 3-3 Leveling the Scale

To compensate for small irregularities or inclinations at the location, the scale can be leveled. The scale is equipped with a level indicator at the front panel .Adjust the leveling feet until the air bubble in the indicator is centered as shown.

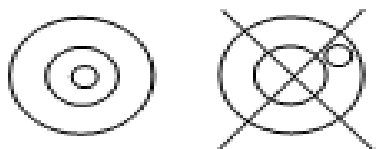

Note: The scale should be leveled each time **once** its location is changed.

## 4. Product Introduction

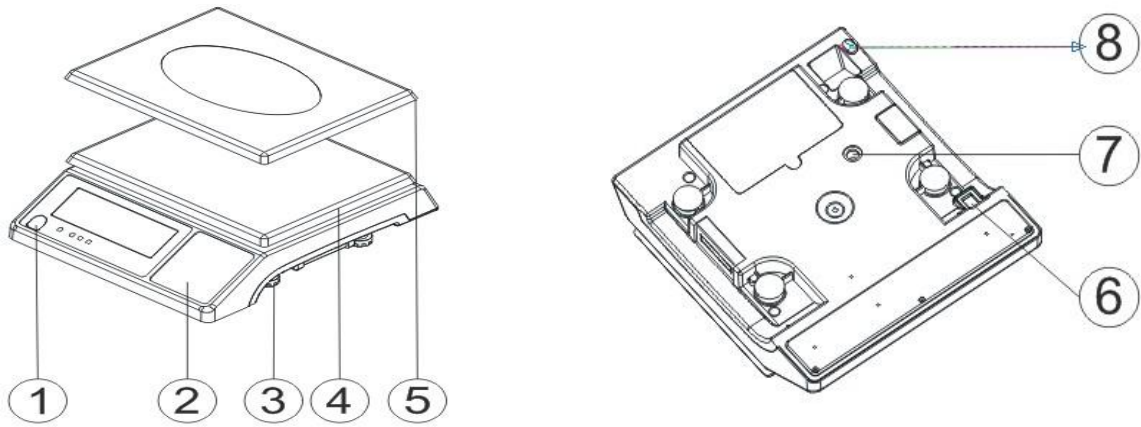

- ① Leveler
- ② Keypad
- ③ Adjusting feet
- ④ Plastic weighing pan
- ⑤ Stainless Steel weighing pan
- ⑥ On/Off switch
- ⑦ Transport protection screws
- ⑧ Power socket

### 4-1 Specifications & General Features

#### Specifications

Model	JWN-3K	JWN-6K	JWN-15K	JWN-30K
Capacity (Kg)	3	6	15	30
Display	LCD(liquid crystal display), digits 31mm high, with back lighting			
Pan size	294 x 228 x 13.5mm			
Scale Dimensions	330 x 289 x 104mm			
Power Supply	DC9V/400mA or built-in rechargeable battery (6V/4A)			

#### General Features

- **Built-in rechargeable batteries or DC alternative**
- Multiple functions: tare, preset tare, simple counting, check weighing, accumulation and display for every deal.
- Large bright backlit LCD with prominent 31mm high digits and LED backlight
- Software filtering design and adjustable weighing displaying speed according to different environments.
- Easy operation with big keys and high weighing resolution
- Single point calibration and linear calibration available
- RS-232 serial communication interface and **Relay port optional (PC, printer, relay)**

## 4-2 Display

### 4-2-1 LCD Display

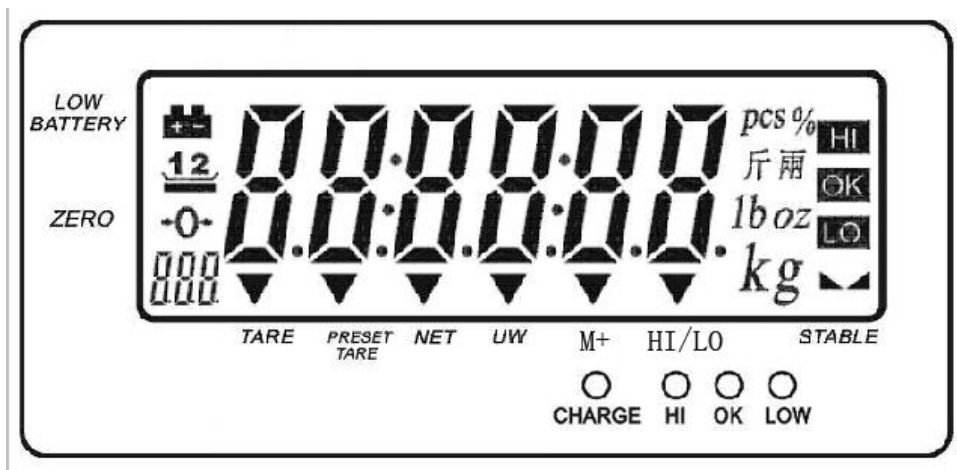

Low battery indication



Tare or Preset Tare Indication



Center of Zero Indication. The zeroing range is  $\pm 2\%$  of weighing capacity.



Auxiliary display (parameter, accumulated number of weighments)

**TARE** Symbol "▼" points at "**TARE**" when manual Tare action is done.

**PRESET TARE** Symbol "▼" points at "**Preset Tare**" when preset tare value is set.

**"NET"** Net weight--Gross weight minus Tare. Symbol "▼" points at "**NET**" when manual Tare or preset are actions are done.

**"UW"** Under simple counting mode, Symbol "▼" points at "**UW**" when unit weight is lower than 4/5 of scale division. Unit weight is too small for ensuring accurate quantity calculations.



Charge Lamp

CHARGE

Red--- battery is charging

Green---battery is fully charged

**HI LAMP ON** The weight on the weighing pan is greater than the upper limit.

**OK LAMP ON** The weight on the weighing pan is between upper and lower limits.

**LOW LAMP ON** The weight on the weighing pan is smaller than lower limit.

PCS %  
斤兩  
lb oz  
kg

Units of measure



Stable indication

## 4-2-2 Keyboard

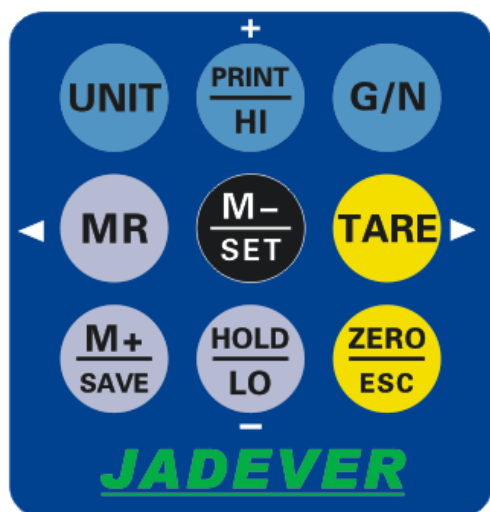

UNIT	Short press steps through activated weighing units, release on desired one.
G/N	Displays gross and net weight by turns
TARE	<ol style="list-style-type: none"> <li>1. Tares the weight of the container or accepts the keypad tare entries</li> <li>2. Preset Tare and Cancel the tare</li> <li>3. Select the later parameter in the same level</li> <li>4. Select the later record when checking the accumulation record</li> <li>5. Shift keys rightwards</li> </ol>
ZERO ESC	<ol style="list-style-type: none"> <li>1. Zeros the display (within 2% of max.capacity)</li> <li>2. Exits from certain operation without save</li> </ol>
M- SET	<ol style="list-style-type: none"> <li>1. Long press to enter function setting</li> <li>2. Deletes accumulation records</li> <li>3. Delete the present accumulation record for the sake of wrong accumulation operation under the accumulation mode.</li> </ol>
M+ SAVE	<ol style="list-style-type: none"> <li>1. Adds the indicated weight into accumulation memory</li> <li>2. During editing, save and return to the higher option</li> </ol>
MR	<ol style="list-style-type: none"> <li>1. Select the former parameter in the same level</li> <li>2. Select the former record when checking the accumulation record</li> <li>3. Shift keys leftwards</li> </ol>
+ PRINT HI	<ol style="list-style-type: none"> <li>1. During setting value, add 1 to the current value</li> <li>2. Set the upper limit of the check weighing</li> <li>3. Print</li> </ol>



1. During setting value, deduct 1 to the current value
2. Set the lower limit of the check weighing
3. Hold function

### 4-3 Power supply

Please verify the local power source before plugging into the power outlet, and use the individual power socket and original adaptor.

#### Alternative power supply

- 1) (9V/400mA) adaptor
- 2) (6V/4A) Internal Rechargeable Battery

#### Power Consumption

About 300 mW without backlight

About 380 mW with backlight

#### Low Battery Warning

When  appears in the upper left corner of the weight window, the battery requires recharging. The charge lamp turns green from red when the recharging is completed (which takes about 8 hours). **Disconnect** the scale from power supply when it is fully charged.

## 5 Function Setting and Description of Parameter Values

### 5-1 Function Setting

1. Press and hold **M-/SET** while powering on or long press **M-/SET** under normal weighing mode to enter function setting. The window displays “**check**”. Setting item “**P00**” displays momentarily at the left bottom
2. Press **◀/MR** or **TARE/▶** to shift between the functions
3. Press **M-/SET** to enter the parameter setting.
4. Press **◀/MR** or **TARE/▶** to shift between the function parameters
5. Press **M+/SAVE** to save and return.
6. Press **ZERO/ESC** to exit without saving and return to the normal weighing model.

### 5-2 Description of Parameter Values

1. **P00:**  **Offset value**

Displays the offset value and the keypad testing can be conducted

2. **P01:**  **Backlight mode**

**Off** : No backlight

**Auto** : Auto on once get a stable weigh data or any key is pressed. But auto off after N

---

seconds (N=2s, 5s, 10s, 20s, ever) with no action. Ever= It is always on when the weights over 9e

**On :** Backlight on

3. **P02:**  **current using units setting**

**Init :** Press key **Unit** to select the default unit when powering on the scale: pcs, 斤, lb. oz, g, kg, final .(final=keep the final being used unit when power off )

**Use:** Press key **Unit** to select the weighing unit. **on :** Enable the unit **off :** Disable the unit

4. **P03:**  **zero range setting: d0, d1, d2, d3, d4, d5.**

d0 (one division) , d1 (2 divisions), d2 (3 divisions), d3 (4 divisions), d4 (5 divisions) and d5 (6 divisions)

5. **P04:**  **Hold function**

**HoLd 0 :** no hold function

**HoLd 1 :** Peak hold. Press any key to release

**HoLd 2 :** Hold after stable. Press any key to release

**HoLd 3 :** Hold after stable. Release after moving away the article. The hold value is based on the current value and its range could be set in sub menu. Accumulation hold function is available, that is you could add article after hold the first value.

**HoLd 4 :** Press key **HOLD/LO/-** to hold. Press any key to release

Sub menu for Hold 3: INF (default: infinity) /10 /20 /50 /100 /200 /500 /1000 2000 /5000 /10000 /20000 /50000

H=current hold value, R=hold value range, d= division, W= actual weight

Keep to hold the value when  $|W-H| \leq R*d$ , or the scale will exit the hold function. The scale will cancel the hold function when empty the weighing pan, if choose INF setting.

6. **P05:**  **whether to save the upper & lower limit of quantity checking: on, off**

**OFF =** previously set quantity checking values are not retained when the unit is turned on.

**ON =** previously set quantity checking values are retained when the unit is turned on.

7. **P06:**  **Check weighing function**

**on:** Check weighing under the condition that the weight is within the limits and the stable indication appears

**off:** Check weighing under the condition that the weight is within the limits

8. **P07:**  **Check Weighing buzzer beep**

**Hi :** There will be a warning sound when the weight of articles exceeds the upper limit, and

---

the weight is equal or more than 20d

**LO**: There will be a warning sound when the weight of articles exceeds the lower limit, and the weight is equal or more than 20d

**ok** : There will be a warning sound when the weight of articles is between the upper and lower limit (including the upper and lower limits), and the weight is equal or more than 20d

**out** : There will be a warning sound when the weight of articles is beyond the upper or lower limit, and the weight is equal or more than 20d

**no.beep** : no beep

9. **P08: PCE External device**

BP = Birch printer (BP545, TDP643)

GD = Godex printer

ZB = Zebra printer

**GP** = Adhesive sticker label printer (paper size 5cmx3cm)

DM = Dot matrix printer (SH-24)

EL = Large LED display

PC = Computer

MS = Connecting the weighing managing system

CL = CX large screen display (version 0.02)

CH = Thermal printer (Chinese available)

CLCont = the output format is compatible with Toledo Continuous Mode

**Note**: Special setting is needed by distributor if you want to print in Chinese.

EXCEL = Work with the function of "Use Serial Keys" in Windows in outputting the data to Excel or others. Reference user manual: <http://www.jadever.com.cn/Download.aspx>

**U.KEY**: U.KEY connector works with PC to send the weighing data to computer (WinXP/Win7) in form of Excel and so on.

10. **P09: Baud RS-232 Serial Transmission Rate**

9600 , 4800 , 2400

11. **P10: Print Print mode**

**contin** : Continuous print

**stable** : Printing automatically when get a stable weight (more than 20d)

**key** : Manual print by pressing the key **PRINT**

12. **P11: Print printing format setting: prt01~prt03**

Use the numeric key to set the format directly.



---

13. **P12:**  **Filtering setting: 1, 2, 3, 4**

Set the filtering level in which the stable indication turns on. The higher the setting, the slower stabilization time

14. **P13 :**  **Precondition for zeroing or taring setting: **stable, auto, always****

**stable** : Taring or zeroing can be not action without stable indication after pressing the key **TARE** or **ZERO**

**always**: Taring or zeroing can be action without stable indication after pressing the key **TARE** or **ZERO**

**auto**: Press key **TARE** or **ZERO**, but it works only when get the stable indication.

15. **P14:**  **Zero-Offset function.**

**ON** display the previous weight when powering on again

**OFF** not display the previous weight when powering on again

16. **P15:**  **Initialization**

Press **M-/SET** then press **M+/SAVE** to **start** initialization and the window display **RESET**.

## 6. Calibration

**Note:** Before calibration, please set the unit first. The unit used in calibration **must be** the one that has been set before (**P02:** ). During the calibration procedure, press **ZERO/ESC** to return to normal weighing mode without saving.

Here we take 3kg/1g as an example

1. Press and hold **TARE** while powering on. Do not release it till the window displays "**CAL**".
2. With no load on the weighing pan, press **TARE** to start zero point calibration. "**0.00**" is blanking at the left bottom.
3. Wait till the window displays the first calibration value. "**0.00**" appears at the left bottom.

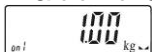

**Note:** The first calibration value is default. With the same capacity, the last first calibration point value can be recorded. If the capacity has been changed, the default value is 1/3 of full load. If you need to change the value, do as the following: Press **M-/SET** to enter the value setting. Press **◀/MR** or **TARE/▶** to move leftwards or rightwards. Press **+/PRINT/HI** or **HOLD/LO/-** to change the value. Press **M+/SAVE** to save.

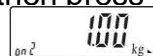
4. Put the corresponding weight on the weighing pan, and then press **TARE** to complete the first point calibration. "**0.00**" appears at the left bottom. 

**Note:** After the first point calibration, the window can display the weight value. If no need

for the other point calibration, move to step 6 to finish the calibration procedure.

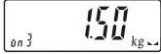
5. Add another mass to the current weight. The window will show the total weight. Press **TARE** to complete. “0000” appears at the left bottom. 
6. Press **M+/SAVE** to save. After the window displays “0000”, it will return to normal weighing mode.

## 7. Operation

### 7-1 Weighing

Begin with no load on the scale, the display reads zero. Place item(s) to be weighed on the scale. The display shown is 1000.0g, gross weight. (The desired weighing unit should be selected before weighing, refer to section 7-5.)



### 7-2 Manual Tare & Preset Tare

When weighing a sample that must be held in a container, **tare and store** the container weight into memory.

#### Manual Tare

- 1) Under the weighing mode, place the container on the weighing pan, wait till stable symbol appears, and press the key **TARE**. The container is tared.



- 2) Place the item(s) to be weighed into the container. The weight displayed is the net weight.

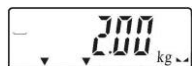

- 3) Remove all items from the weighing pan; the screen displays the tare value.

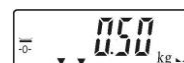

- 4) To clear tare with an empty pan, Press down key **TARE** or key **ZERO/ESC**.

#### Preset Tare

- 1) Long press key **TARE** for 3 seconds. The scale is now in Digital inputting mode with the

left-most digit blinking. 

- 2) Press **◀/MR or TARE▶** to move leftwards or rightwards. Press **+ /PRINT/HI or**

**HOLD/LO/-** to change the value. Press **M+/SAVE** to save and return to weighing

mode.  

- 3) Put the load on the container, the scale will automatically deduct the value of the container from the total value.

**NOTE:** Press Key **G/N** to display gross and net weight by turns.

- 4) Clear the load on the container, and press **TARE▶** or **ZERO/ESC** to cancel the

pre-tare.

## 7-3 Check Weighing

### Lower limit setting

1. Begin by pressing down key **HOLD/LO/-**. The scale is now in digital inputting mode with

the right-most digit blinking. 

2. To set the value of lower limit, press key **◀/MR** to shift leftwards, key **TARE▶** to shift rightwards, key **+/PRINT/HI** to increase setting values and key **HOLD/LO/-** to decrease setting value. Key **M-/SET** to enable or disable the weighing checking function.



3. To save the Lower limit and return to weighing mode, Press key **M+/SAVE**

### Upper limit setting

1. Begin by pressing down key **+/PRINT/HI**. The scale is now in digital inputting mode with

the right-most digit blinking. 

2. To set the value of upper limit, press key **◀/MR** to shift leftwards, key **TARE▶** to shift rightwards, key **+/PRINT/HI** to increase setting values and key **HOLD/LO/-** to

decrease setting value. 

3. To save the upper limit and return to weighing mode, press key **M+/SAVE**

#### Note:

Place the sample on the weighing pan, if the sample weight is under the lower weight range while over or equal 20d, the LOW lamp will light up. If the sample is within the lower and upper weight range while over or equal 20d, the OK lamp will light up. If the sample is over the upper weight range while over or equal 20d, the HI lamp will light up.

**When changing the Hi-Lo value, the scale will activate the weighing checking function automatically. If the Lo value is higher than Hi value, then the Hi value will become the same value as Lo data.**

## 7-4 Simple Counting

1. Press key **UNIT** to select the unit "PCS". 

Note: Ensure to activate the unit "pcs" before operating, see the setting of **P02: Unit**

2. Long press key **G/N**, the ex-factory default sample quantity (10 pcs) is displayed.

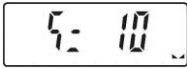

3. Use key **+/PRINT/HI** or **HOLD/LO/-** to choose the sampling amount. Available options are 10、 20、 50、 100、 200、 500、 1000( pieces) .

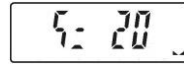

4. Put the corresponding samples on the weighing pan, and then press key **TARE/▶**.

“**5000**” is displayed momentarily before the display reverts to the sample quantity.



5. Remove the samples and put the load on, the scale calculates the amount of the load.

6. To go back to the normal weighing mode, remove the load and press key **UNIT** to select the proper weighing unit.

**Note:**

- 1. The larger the sample size, the more accurate unit weight.
- 2. Symbol “▼” points at “UW” when calculated unit weight is lower than 4 / 5 of scale division.

## 7-5 Accumulation, Accumulation Display and Accumulation clear

### Accumulation

Under the weighing mode, put the item on the weighing pan. Press key **M+/SAVE** at the appearance of “▲▲”. “**00001**” is displayed momentarily before the display reverts to the weight of the item.

Remove the item and the display goes back to zero before the next accumulation can register.

( The maximum is 99 pieces, display the latest 10 accumulation events in details )

### Accumulation Display

Press key **◀/MR** to display the accumulation data.

Press key **◀/MR** or **TARE/▶** to check a total accumulation event and each accumulation event in detail.

The number of accumulated weight is indicated at the left bottom.

⌂XX= total accumulation event ; ⑈XX= the single accumulation

### Accumulation Clear

To clear accumulation data (total accumulation data or one of the latest 10 accumulation events), press key **◀/MR** to display the accumulation data needed and press key

**M-/SET** to clear data chosen. When clear total accumulation data, the accumulation signal “ ▼ ” will disappear and back to normal weighing mode. If need to exit without clearing data

and return to normal weighing mode , press key **ZERO/ESC**.

## 7-6 Printer initialization by the indicator operation

1. Press **M-/SET** while powering on to enter parameter setting. Use key **◀/MR** or **TARE▶** to shift to P09 **Pr i**
2. Press **M-/SET** to enter the external device setting. Press **◀/MR** or **TARE▶** to choose the printer model
3. **After choosing one printer model**, press **M-/SET** and the window will show “UNSUP” or “INIT?”
  - “UNSUP” means the printer can’t be initialized by scale. Press **ZERO/ESC** to return.
  - “init?” means the printer is should be initialized. Press **MR/SAVE** to initialize the printer. When the initialization is finished, the window will show “ok”. And then displays the printer model. Press **ZERO/ESC** to return.

## 7-7 Input commands

Connect the **scale** to computer. Run serial port debugging program on the computer. Input the capital number “Z”, “T”, “R” ,“C”,“P” in the sending area, and the indicator can conduct the corresponding actions.

Z=zero

T=tare

C=cancel tare

R/P=reading / print

## 8. Serial Interface

If external interface is needed, please select the proper RS 232 board **or Relay port** firstly, and only when this board is adopted, the functions can be enabled.

Note: RTC is **unavailable**.

### 8-1 RS-232 Diagram

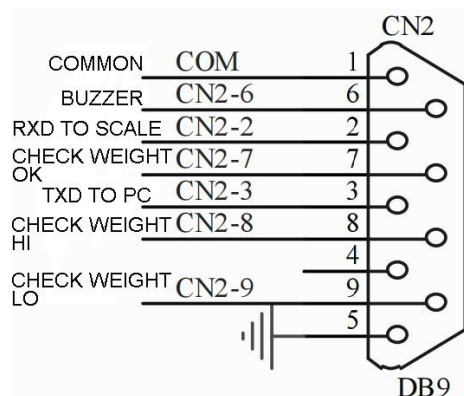

## 9. Troubleshooting and Error Message

Error Message	Problem	shootings
ERR0	Exceed the zero range	The item should be within 2% of full load
ERR2	Exceed the initial zero point	1. Check whether there are other alien articles on the scale pan, remove those articles. 2. LOAD CELL failure, which requires to be changed or to contact our Service.
ERR3	Exceed the A/D resolution range	1. Check whether it is A/D failure, if yes, please replace AD. 2. LOAD CELL failure, replacement is required or contact our Service.
ERR4	EEPROM failure	Re-sold EEPROM or contact our Service.
ERR5	Overload condition	Remove weight that is greater than the scale capacity from the pan.
ERR6	Exceeds the display range	-----
ERR7	Accumulated number of <b>weights</b> exceeds the display range	Delete the exceeding <b>weights</b>
ERR8	<b>Weight limit value is higher than the full load value</b>	Reset the weight limit value.
ERR9	Exceed tare or pre-tare range	The tare value should be over zero and less than or equal to full load.
ERR10	Wrong calibration weights	Place the right weights( the calibration value $\leq$ full load)

### Appendix 1: Printing format (Optional)

Printing Device	Format	Sample
PC	<b>prt-01</b>	<b>1. 000 kg</b>
	<b>prt-02</b>	G.W.: 1. 500 kg T.W.: 0. 500 kg N.W.: 1. 000 kg
	<b>prt-03</b>	<b>1. 000 kg</b>

	<b>prt-04</b>	<div style="border: 1px solid black; padding: 2px; margin-bottom: 5px;">ST GW + 100.00</div> <div style="border: 1px solid black; padding: 2px; margin-bottom: 5px;">UT GW + 100.00</div> <div style="border: 1px solid black; padding: 2px; margin-bottom: 5px;">UT NW - 200.00</div> <div style="border: 1px solid black; padding: 2px; margin-bottom: 5px;">ST NW - 200.00</div> <p>ST: stable; UT: unstable; NW: net weight; GW: gross weight</p>
	<b>prt-05</b>	<div style="border: 1px solid black; padding: 2px; margin-bottom: 5px;">ST, GS, + 100.00kg</div> <div style="border: 1px solid black; padding: 2px; margin-bottom: 5px;">US, GS, + 100.00kg</div> <div style="border: 1px solid black; padding: 2px; margin-bottom: 5px;">US, NT, - 200.00kg</div> <div style="border: 1px solid black; padding: 2px; margin-bottom: 5px;">ST, NT, - 200.00kg</div> <p>ST: stable; UT: unstable; NW: net weight; GW: gross weight</p>
	<b>prt-06</b>	<div style="border: 1px solid black; padding: 2px; margin-bottom: 5px;">ST, + 100.00kg</div> <div style="border: 1px solid black; padding: 2px; margin-bottom: 5px;">ST, - 100.00kg</div> <p>"ST," is the prefix</p>
<b>BIRCH/GODEX/ZEBRA/GP /CK</b>	<b>prt-01</b>	<div style="border: 1px solid black; padding: 2px; margin-bottom: 5px;"><b>1.000 kg</b></div>
	<b>prt-02</b>	<div style="border: 1px solid black; padding: 2px; margin-bottom: 5px;"> <b>G.W.: 1.500 kg</b>  <b>T.W.: 0.500 kg</b>  <b>N.W.: 1.000 kg</b> </div>
<b>CK</b>	<b>prt-02</b>	<div style="border: 1px solid black; padding: 2px; margin-bottom: 5px;"> <b>G.W.: 1.48 kg</b>  <b>T.W.: 0.00 kg</b>  <b>N.W.: 1.48 kg</b> </div>
<b>DMP</b>	<b>prt-01</b>	<div style="border: 1px solid black; padding: 2px; margin-bottom: 5px;"><b>1.000 kg</b></div>

	<b>prt-02</b>	G.W.: 100.00 kg T.W.: 0.00 kg N.W.: 100.00 kg
	When <b>RD3</b> appear under display of accumulation, press key PRINT to the print out.	(01) 1.765 kg (02) 1.760 kg (03) 1.760 kg ----- (03) 5.285 kg

**NOTE:**

The printing sample could be of different kinds of formats. When there is specific demand about the format, conduct as follows

- 1) As for **BRICH/GODEX/ZEBRA/GP** printers, the factory designs the format as planned and email to the user. Add the format into the previous format file via computer. Then it is successful to add the new format and able to print the new format.
- 2) As for **DMP/CK** printer, it needs to change the scale design

**Appendix 2: Exporting data to PC in the form of EXCEL**

**Introduction:**

Connect the scale with PC and set the parameter of external device as “EXCEL” on the scale, then you could export the weighing data to PC in the form of EXCEL. With this function, you could record/accumulate/average/data statistical analysis the testing data, which we could call it as **scale-computer data management function**.

**Note:** pls enable “Use Serial Keys” function in the computer.

**Hardware connection and settings**

1. Use transmitting serial wire or USB wire to connect scale and pc.  
Note: pls install usb driver first, if you use usb wire.
2. Parameter settings in scale:

"PERI" = "EXCEL"	(external device)
"BAUD" = "2400"/"4800"/"9600"	(baud rate)
"PRT.M" = "KEY"/"STABLE"	(printing model)
"PRT.F" = "PRT.F01"	(printing format)



## Enable the function of “Use Serial Keys” in the computer

Set Windows XP as a example:

1. Press “Start” ->”Run”, and enter “access.cpl” ->”OK”.

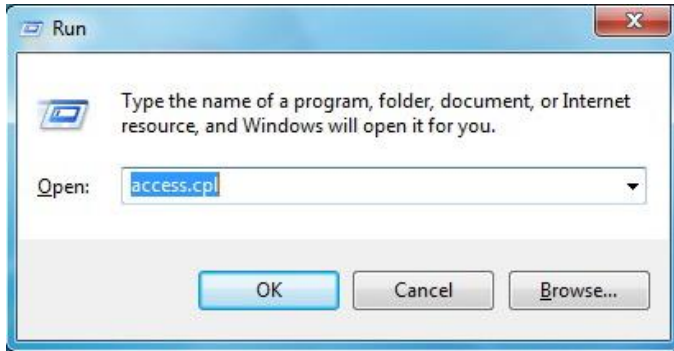

2. In the dialog box “Accessibility Options”, enter General option, choose “Use Serial Keys” and press “Settings”.

In the dialog box “Settings for SerialKeys” , set the corresponding Serial port and Baud rate, which should be same as Baud rate in scale.

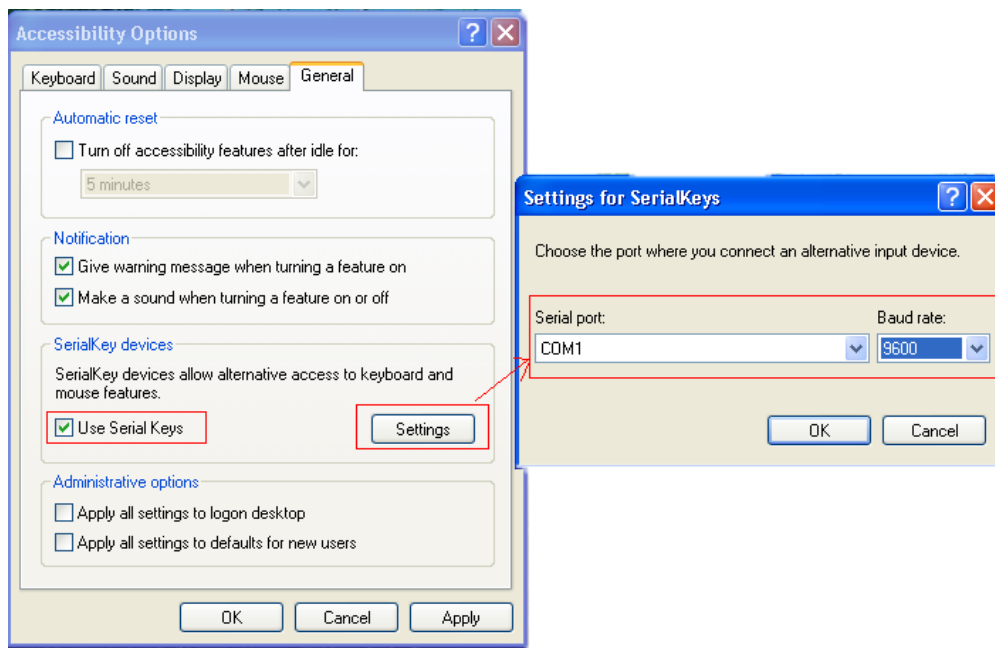

3. Test if Serial Keys works well.

Open a Text Document, and press the Print buotton on the scale. The Serial Keys works well, if pc exports the weighing data to Text.

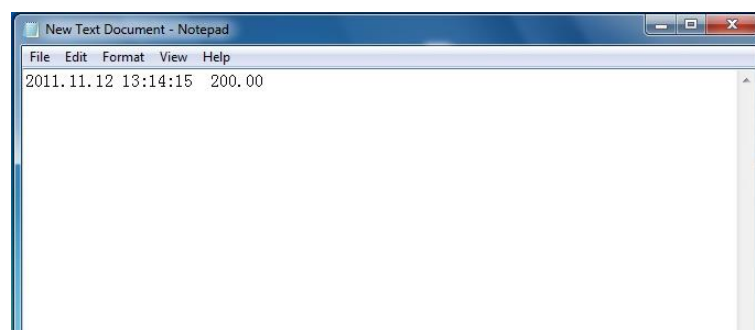

## Export weighing data to Excel

1. Open Excel.
2. Press [Print], then Excel will show Date and Weighing data.

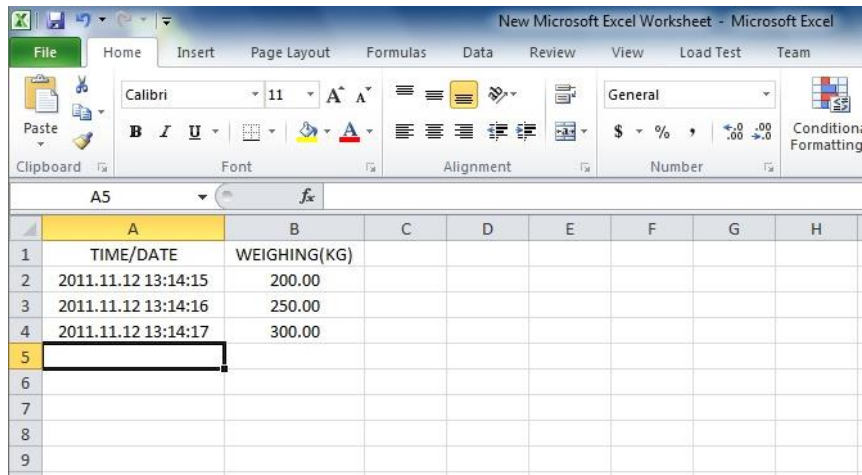

The screenshot shows a Microsoft Excel worksheet with the following data:

	A	B	C	D	E	F	G	H
1	TIME/DATE	WEIGHING(KG)						
2	2011.11.12 13:14:15	200.00						
3	2011.11.12 13:14:16	250.00						
4	2011.11.12 13:14:17	300.00						
5								
6								
7								
8								
9								

3. Use “Format Cells” to beautify Excel:

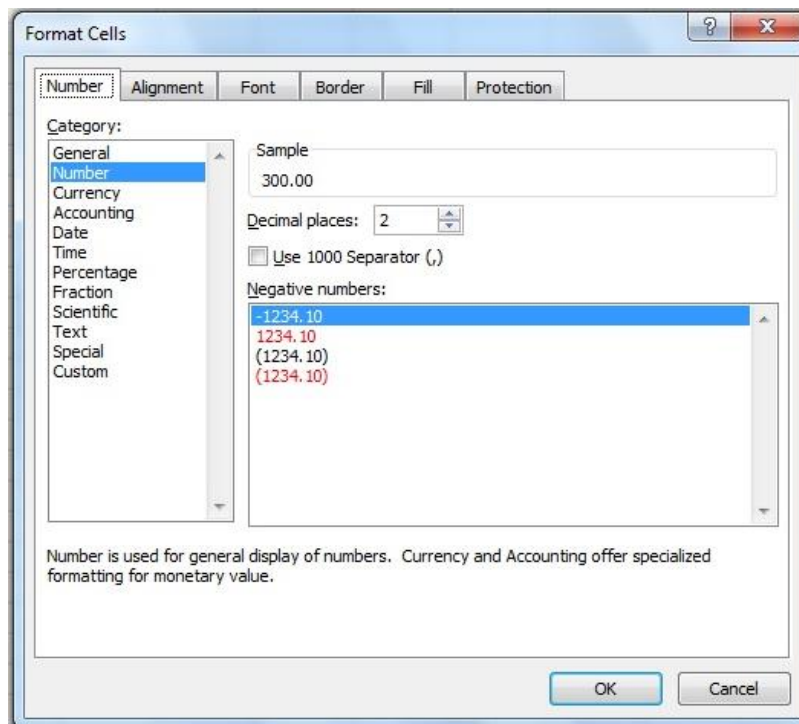

## Troubleshooting

1. Enable “Fast User Switching” function will disable “Use Serial Keys” in the computer.  
Note: Start->"Control Panel "->"User Account"-> “Fast User Switching” function.
2. The data export requires only “GND+RX+TX” three lines, while some wire include nine lines (including usb 9-25pin adapter), which may cause abnormal function.  
Note: cut other useless line to check if these three lines work well.

## Appendix 3: U.KEY Connector

### 一、 Introduction

Connect the scale with PC and set the parameter of external device as "U.KEY" on the scale, then you could export the weighing data to PC in the form of EXCEL. With this function, you could record/accumulate/average/data statistical analysis the testing data, which we could call it as **scale-computer data management function**.

Most importantly, you don't need any setup in computer, but only use U.KEY connector to link computer system directly, such as EXCEL, Express System, ERP system and so on. This connector is compatible with windows2000/xp/Vista/win7/win8/Linux/Android system, and the weighing data will show on the position where the mouse cursor in.

With one USB port, you could connect scale to computer easily.

### 二、 Precaution

1. Close the input method program before connecting.
2. Ensure the decimal point digit is same as the parameter setting of scale, if use EXCEL file in computer.

For Example:

Scale shows: Total Weight: 1.000KG 、 Unit Weight: 0.001g、 Total: 1000PCS

EXCEL Setting: the decimal point digit should be 3 for total weight and unit weight column, and the decimal point digit should be 0 for total column.

### 三、 Setting

1. Prepare one computer with windows2000/xp/Vista/win7/win8/Linux system or Android pad.
2. Scale setting:
  - "PERI" = "U.KEY" (External devices)
  - "BAUD" = "9600" (Baud)
  - "PRT.M" = "KEY"/"STABLE" (Print Mode)
  - "RTC" = "ON"/"OFF" (Time)
3. Open the receiving port such as EXCEL or ECR system, and the weighing data will show on the position where the mouse cursor in

### 四、 Example:

1. EXCEL:

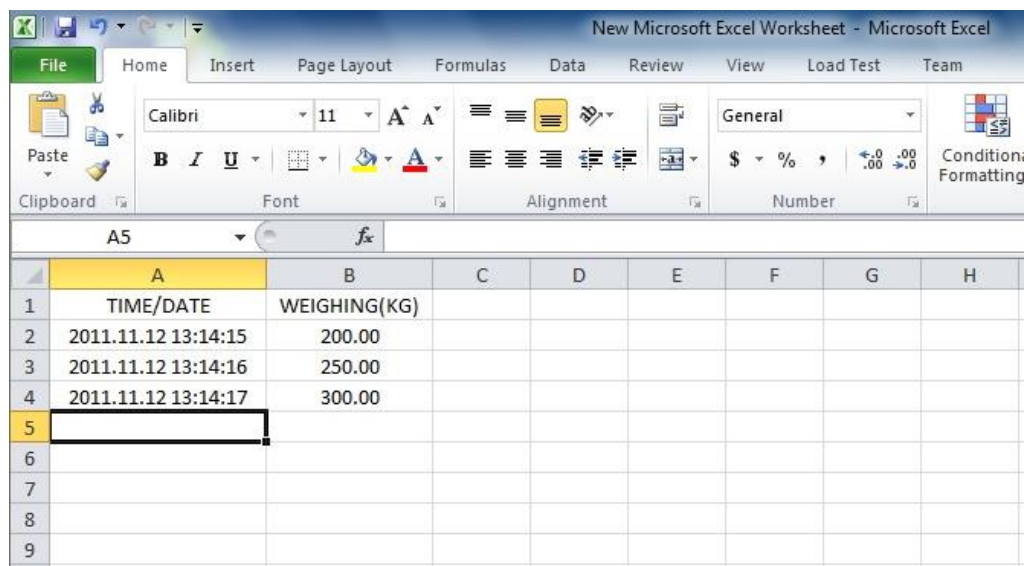

	A	B	C	D	E	F	G	H
1	TIME/DATE	WEIGHING(KG)						
2	2011.11.12 13:14:15	200.00						
3	2011.11.12 13:14:16	250.00						
4	2011.11.12 13:14:17	300.00						
5								
6								
7								
8								
9								

## 2.ERP System:

LOG IN

企业管理软件  
用友ERP-U8  
版本:8.90 精细管理 敏捷经营

EXPRESS ITME: EXPRESS

WEIGHT: 6.44 KG

NO.: 000001

DELIVERY COURIER: MR. Z

AREA: U.S.A

DATE: 2013-08-22

OK RETURN HELP