

MARSDEN

USER MANUAL

M-250

Please take time to read these instructions before starting to use the scale

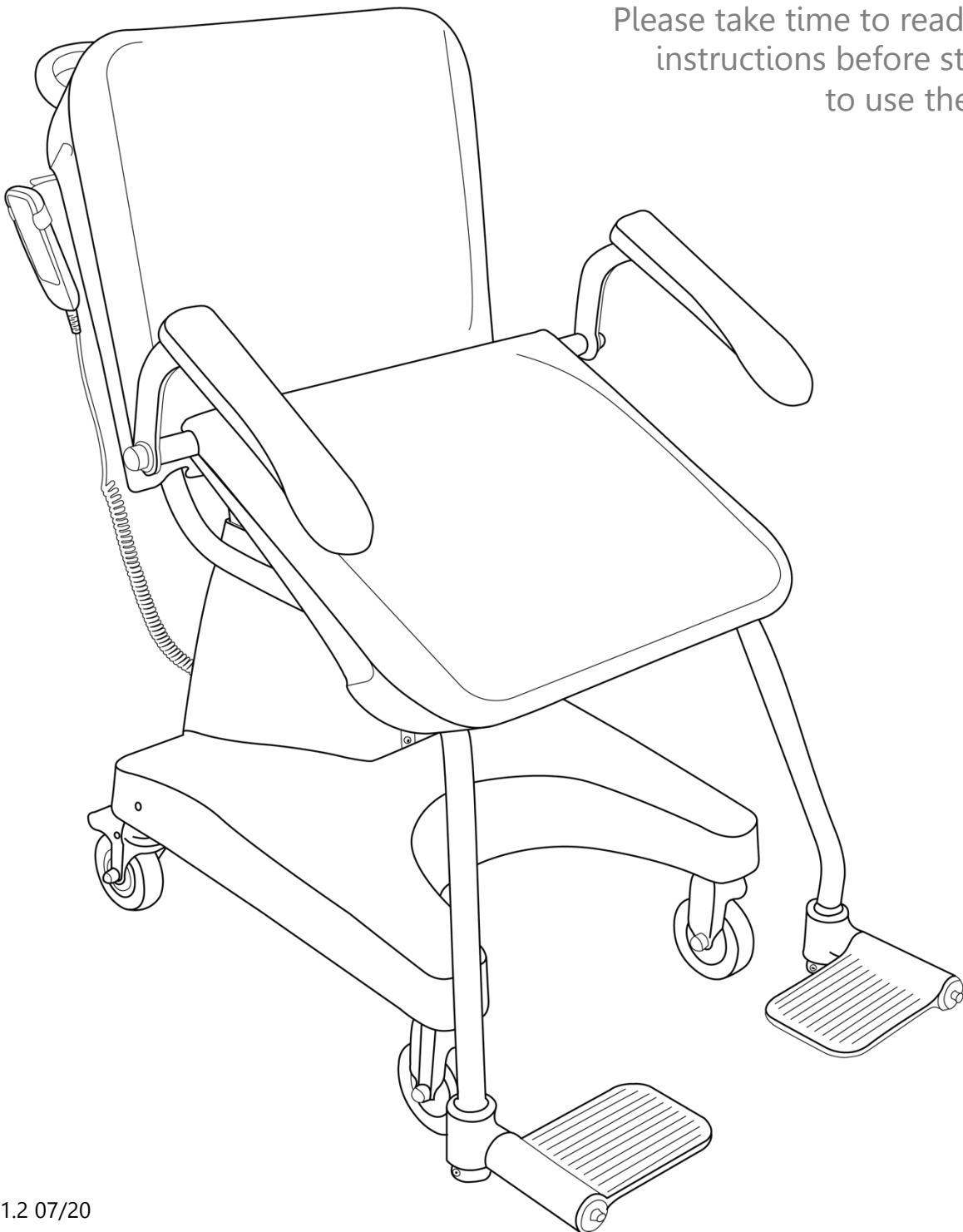

Contents

1. Introduction

- 1.1. Thank you
- 1.2. Intended use

2. Product Specifications

- 2.1. Specifications
- 2.2. Warranty
- 2.3. Spare Parts

3. Safety Information

- 3.1. Safety Instructions
- 3.2. Safe use of batteries
- 3.3. Cleaning the scale
- 3.4. Maintenance
- 3.5. Disposing of the Scale
- 3.6. Explanation of Graphic Symbols

4. Installation

- 4.1. Components included with the Scale
- 4.2. Establishing the Power Supply
- 4.3. Levelling the Scale

5. Operation

- 5.1. Lifting Mechanism & Weighing
- 5.2. Switching off the Scale
- 5.3. Setting the Scale to Zero
- 5.4. Using the Hold Function
- 5.5. Using the Body Mass Index (BMI) Function
- 5.6. Using the Tare and Preset Tare Functions
- 5.7. Setting the Date

6. Additional Features

- 6.1. Using the Scale with a Printer
- 6.2. Using the Scale with Bluetooth

7. EMC Guidance and Manufacturer's Declaration

8. Error Messages

1. Introduction

1.1. Thank you

Thank you for purchasing this Marsden professional medical scale.

This professional, accurate, intuitive device embodies 90 years of weighing experience and ensures that you, the medical professional, are able to weigh individuals easily and effectively.

The M-250 is a precise, Class III Weighing Instrument and considerate use will result in many years of accurate weighing.

The scale has a maximum load capacity of 250kg which must not be exceeded.

1.2. Intended Use

The Marsden M-250 Chair Scale with Stand Assist is ideal for use in hospitals, medical practices and care facilities.

Weighing in these areas is vital to keep a check on a patient's weight, as this can often be the first, the clearest or the only indication of health issues. Chair scales are essential when a patient or resident cannot stand or has limited mobility.

The stand assist feature is designed to reduce the effort required to get a patient in and out of the chair scale. The M-250 can be taken to the patient, rather than the patient being brought to the scale, and the scale's rechargeable battery provides upto 55 hours of continuous use.

The Marsden M-250 is not intended for the transportation of people or objects. Please use the scale only for the purpose named in this section.

2. Product Specification

2.1. Specifications

Model	M-250
Accuracy Class	Class III
Dimensions	1060mm (l) x 660mm (w) x 1010mm (h)
Seat Dimensions	470mm (l) x 540mm (w)
Weight of Scale	56kg
Capacity	250kg
Graduations	100g
Power Supply Rechargeable Battery Pack Power Pack	6 x AA batteries* 12V 1A AC Adaptor
Adaptor Specifications	12V 1A 2.5mm tip +ve
Battery Life (scale)	Upto 3000 weigh ins (or 55 hours of continuous use) from full charge
Battery life (actuator)	Upto 150 lifts from full charge
Units of Measure	Kg
Minimum load	2kg
Stabilization Time	1-2 Seconds
Operating Temperature	0 to 40°C
Function Keys	ON/OFF, HOLD, TARE, BMI, UNIT, 0-9
Indicator Display	2.5cm LCD display with 5 active digits
Actuator Load Capacity	6000N
Actuator Speed	4 ~ 30mm/s
Actuator Input Voltage	24V / 12V DC
Actuator Duty Cycle	2 minutes use/18 minutes on standby

*contact Marsden for details

2.2. Warranty

This scale is covered by our pioneering 4 Year Warranty. The warranty is valid from the date of purchase for faults due to material or construction defects; faults under this warranty are repaired free of charge.

This excludes all moveable parts, such as batteries, cables, adaptors, etc.

It is the responsibility of the customer to return the product to our factory in Rotherham, UK. Claims covered under warranty will be carried out free of charge and Marsden will pay for the return transport costs.

2.3. Spare Parts

The following spare parts are available for this scale.

Scale

Part/Description	Part Number
Foot rest	M-250-FOOT PEDAL
Arm rest	M-250-ARM REST
Load cell – Zemic L6E3 300kg	L6E3 300kg
Front wheel	M-200-W
Rear braked wheel	MPDC250-BW
Seat - base	M-250-SEAT PANEL BOTTOM
Seat – back	M-250-SEAT PANEL
Plastic shroud	M-250-VAC FORM BASE
Actuator – lifting mechanism	M-250-ACTUATOR
Handheld remote and cable	M-250-ACTUATOR HANDSET
Rechargeable battery for lifting mechanism	M-250-ACTUATOR BATTERY

Indicator

DP-3810 Main board	SS90004081
DP-3810 Display board	SS90004201
DP-3810 Battery connecting board	CH0785
DP-3810 Overlay	MP10003991
DP-3810 Keyboard membrane	ME73000622
DP-3810 Battery holder	ST-3301
DP-3810 Battery door	MP04000541
DP-3810 Rechargeable battery pack 2000mA	SE70000291
DP-3810 Adaptor 12Volt 1.0A (TIP+)	LGSPB120100BS
DP-3810 Top housing	MP01001231
DP-3810 Bottom housing	MP02000801

3. Safety Information

3.1. Safety Instructions

Before putting the device into use, please read with care the information given in this user manual, which contains important instructions for proper installation, use and maintenance of the device.

Keep this user manual in a safe place, along with the Declaration of Conformity.

Have the scale serviced regularly (see Maintenance).

Marsden/the manufacturer shall not be liable for damages arising from failure to heed the following instructions:

- When using electrical components under increased safety requirements, always comply with appropriate regulations.
 - When genuine Marsden accessories and spare parts are not used, the warranty will be rendered null and void.
 - Likewise, inappropriate installation/use will also render the warranty null and void.
 - Ensure the voltage marked on the power supply unit matches your mains supply.
 - This device is designed for use indoors.
 - Observe the permissible ambient temperatures for use.
 - If the power pack is used, ensure that the power cable is not a tripping risk. Similarly, ensure that the power cable cannot be crushed or come into contact with hot objects.
 - Do not use the scale to transport any people or objects. This is not the intended use of the scale.
 - The scale is fitted with braked wheels to the rear; these should always be locked before anyone attempts to sit on the chair.
 - The footrests must not be used for standing on. They should be folded away to the side prior to weighing, whilst the individual is assisted into the seat. They should only be used for resting the feet once the patient is seated and then folded away again once the patient has been weighed.
 - Armrests should always remain in the lowered position throughout the weighing process.
-  When adjusting the screw feet of the chair, always ensure that there is at least 15mm of thread inside the frame. If there is less than 15mm, there is a risk the rear braked wheels will fall off.

If you have any problems, contact Marsden/your local dealer/your service partner.

3.2. Safe use of batteries

This scale comes with a rechargeable battery. Please be sure to observe the following safety instructions to avoid personal injury when using these batteries:

Keep batteries out of reach of small children. Should a child swallow a battery, promptly seek medical assistance.

Batteries contain harmful substances, which may explode when mishandled. Keep batteries away from direct sunlight, high temperatures, and high humidity. Do not burn the batteries.

If acid is leaking out of the batteries, avoid contact with the skin, eyes and nose. Immediately rinse any infected area with plenty of clean water and seek medical advice.

Only use the type of rechargeable battery that is specified.

If you are not going to use the scale for a long period of time, remove the batteries to prevent acid from leaking into the device.

3.3. Cleaning

We recommend using alcohol-based wipes or similar when cleaning the scale.

Please do not use corrosive liquids, large amounts of water or high-pressure washers.

Always disconnect the scale from the mains power supply before cleaning.

3.4. Maintenance

The scale does not require any routine maintenance. However, we recommend checking the scale's accuracy at regular intervals (at least every 12 months, depending on frequency of use). If any inaccuracies occur, please contact your local dealer or service partner.

Marsden can provide service contracts in the UK and Republic of Ireland. Please call us on +44 (0) 1709 364296 for more details.

3.5. Disposing of the scale

This product should not be treated as regular household waste, but should be handed in to an electrical/electronic equipment recycling centre.







You can obtain further details from your local council, your municipal waste disposal company or from where you purchased the product.

3.6. Before Use

Safety Instructions can be found on the back of the seat, in front of the indicator. Please follow these instructions before and during use.

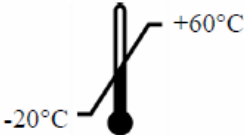

3.7. Explanation of Graphic Symbols

<p>SN-21300100</p>	<p>Designation of the serial number of every device. (Number as an example).</p>
	<p>"Please note the accompanying documents" or "Observe operating instructions".</p>
	<p>Identification of manufacturer of medical product including address.</p>
	<p>"Electro-medical appliance" with attachment of type B.</p>
	<p>Dispose of old appliances separately from your household waste. This product must be disposed of at a communal collection point.</p>
	<p>Carefully read this operation manual before setup and commissioning, even if you are already familiar with Marsden scales.</p>
	<p>Transport and storage temperature limit indicating the upper and lower limit (transport and storage temperature on packaging).</p>
	<p>Device complies with EU standards and directives.</p>

4. Installation

4.1. Components included with the scale

Components	Number of Pieces
Marsden M-250 Chair Scale	1
Adaptor	1
Rechargeable Battery Pack	1
Hand remote	1
Mains power supply	1

4.2. Establishing the Power Supply

The indicator uses a rechargeable battery pack, or can be powered from the mains via the AC adaptor.

Slide the rechargeable battery pack into the housing as shown below.

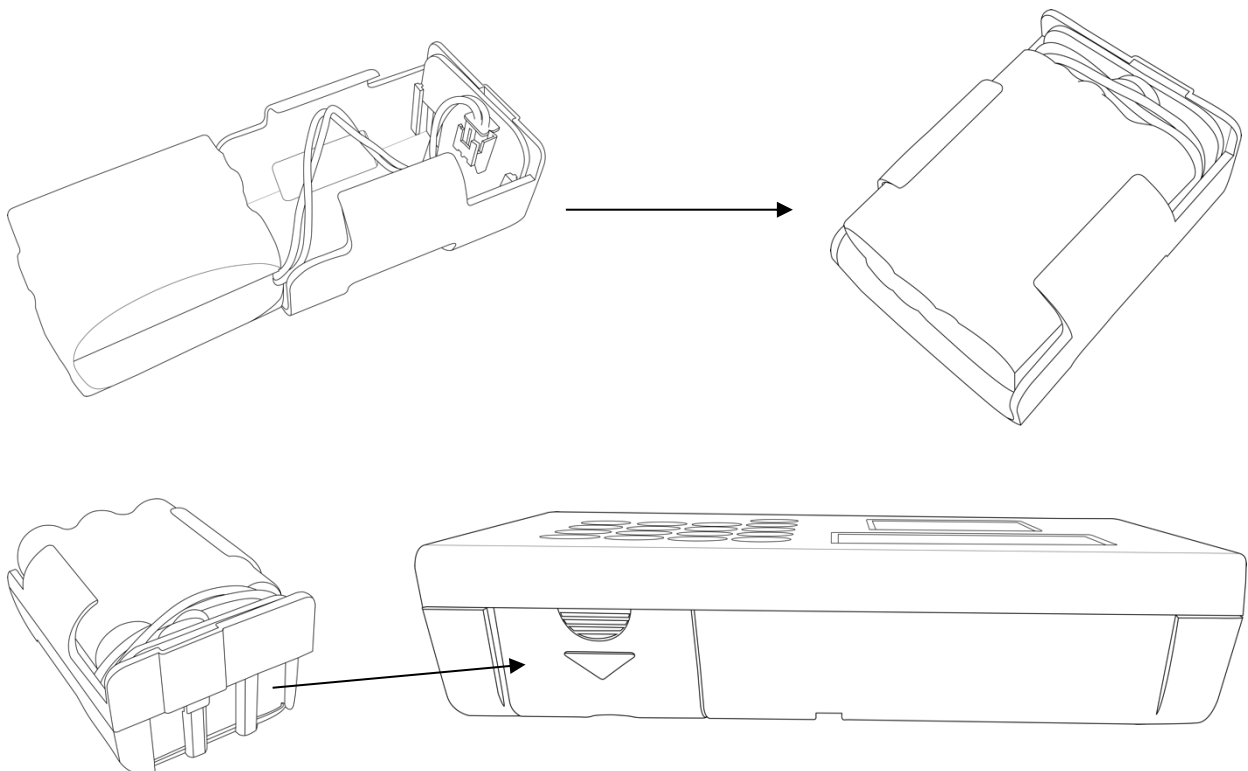

On the indicator, slide the battery compartment cover down to remove. Place the rechargeable battery pack into the indicator's battery compartment. Check that the housing pin is connecting to the right point inside the indicator, and replace the cover.

To power the scale from the mains, or to charge the battery, plug the AC adaptor (12V 1A) into the port on the side of the indicator.

4.3. Levelling the Scale

Place the scale on level ground.

Adjust the height of the chair scale by rotating the rear braked wheels. Please ensure there is always 15mm of thread inside the frame, otherwise there is a risk that the rear braked wheels will fall off.

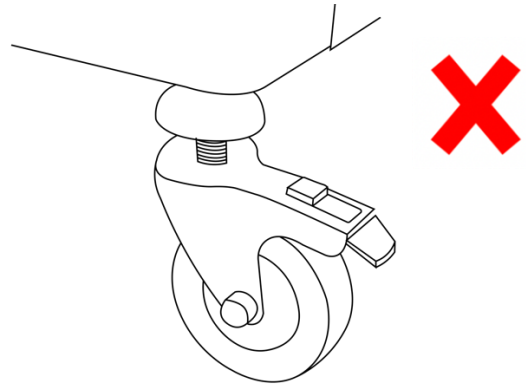
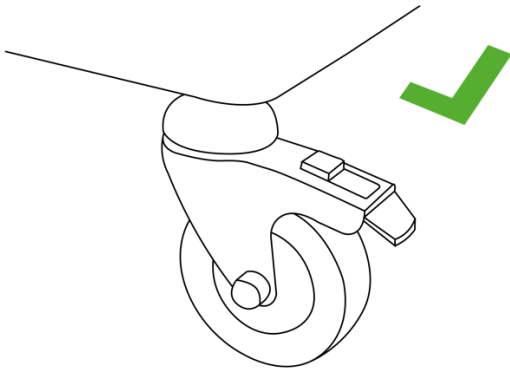

5. Operation

5.1. Lifting Mechanism & Weighing

The M-250's seat base raises and lowers to assist with guiding an individual out of (and into) the seat.

- ⚠ Follow these guidelines for use, but always ensure you follow your local manual handling guidelines when assisting an individual into or out of the M-250's seat.

Before operation, ensure brakes on both rear wheels are applied.

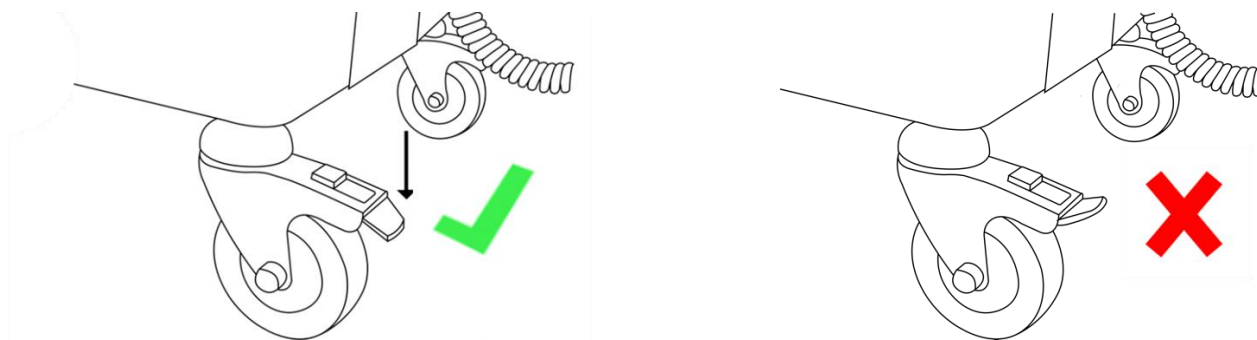

Armrests must be in the lowered position before weighing.

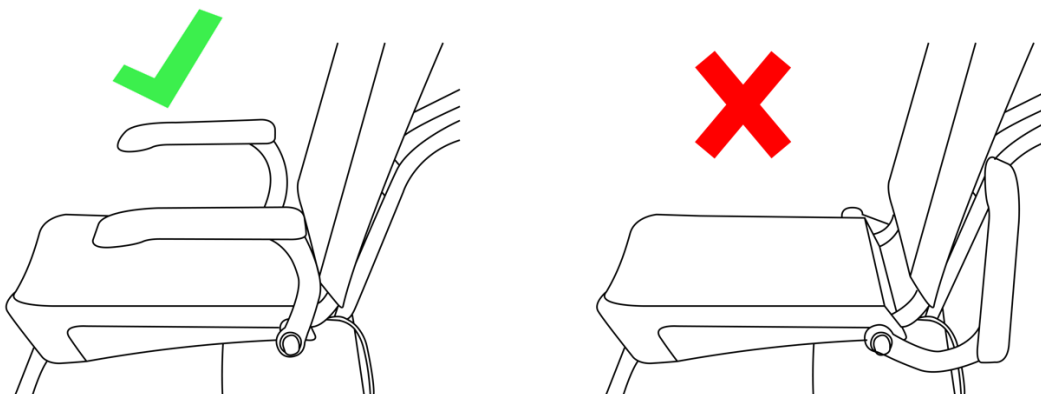

Ensure footrests are rotated to the side.

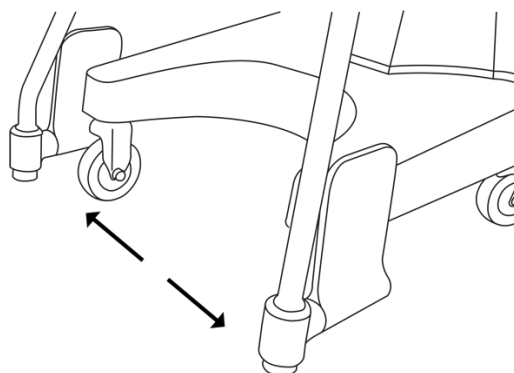

Press the **ON/OFF** button firmly.

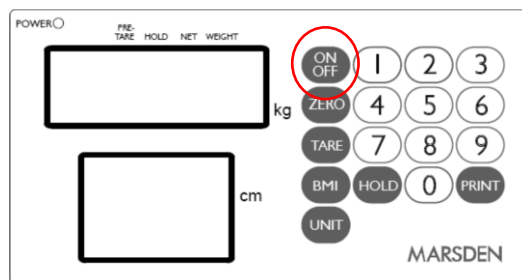

The scale will first test all of the display segments....

...and then show its current software version number.

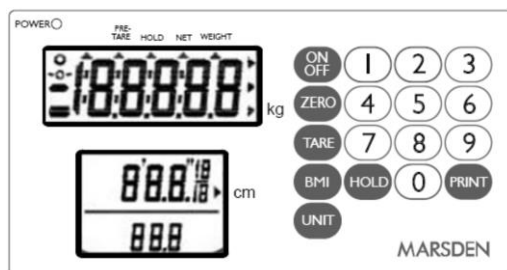
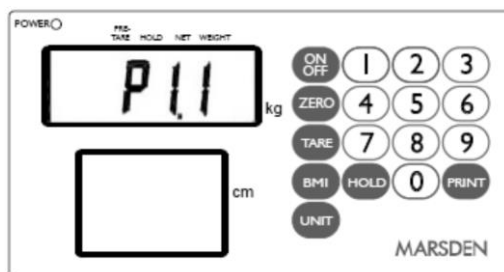

The scale will now go into weighing mode and should show 0.0kg on the display.

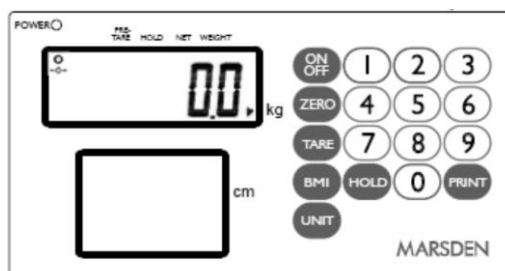

⚠ Prior to a patient or resident being seated, the patient's feet must be firmly on the floor. Footrests must not be used to stand on. They are for weighing purposes only.

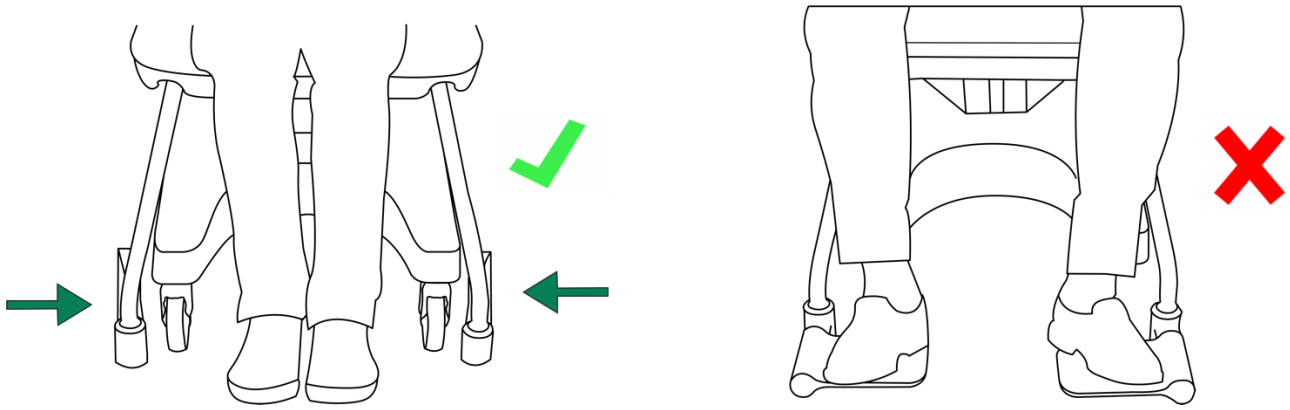

To raise the seat base, press the **UP** button on the handheld remote.

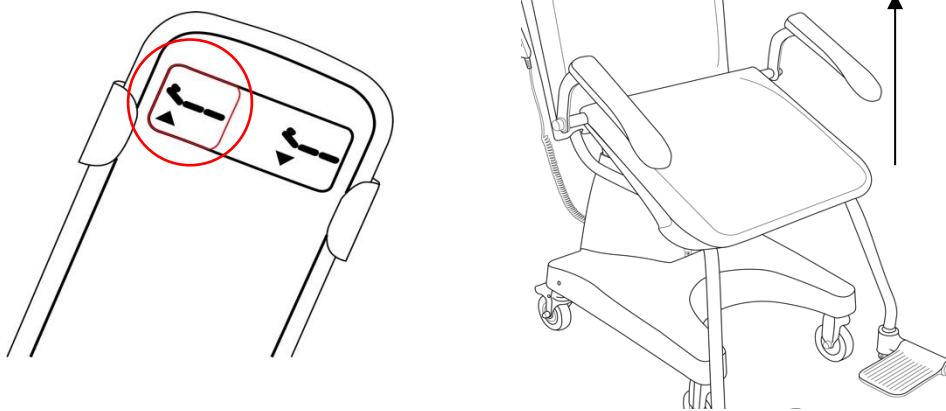

To lower the seat, press the **DOWN** button on the handheld remote.

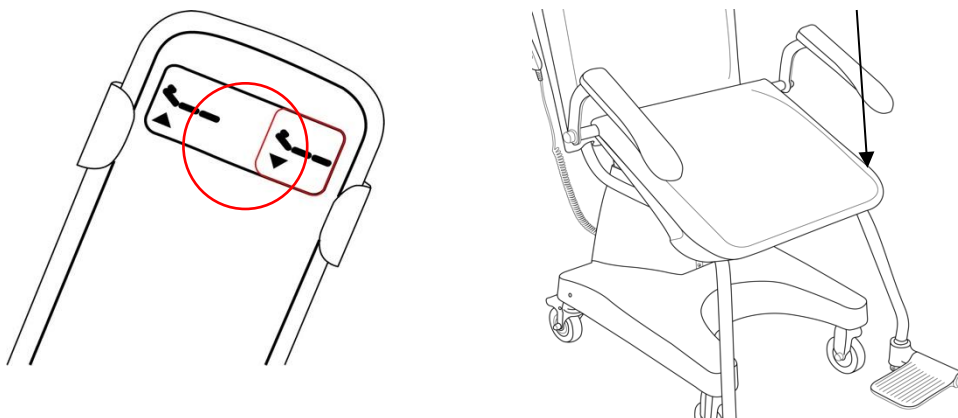

Once the patient or resident is seated, before observing the weight reading, ensure both feet are placed on the footrests.

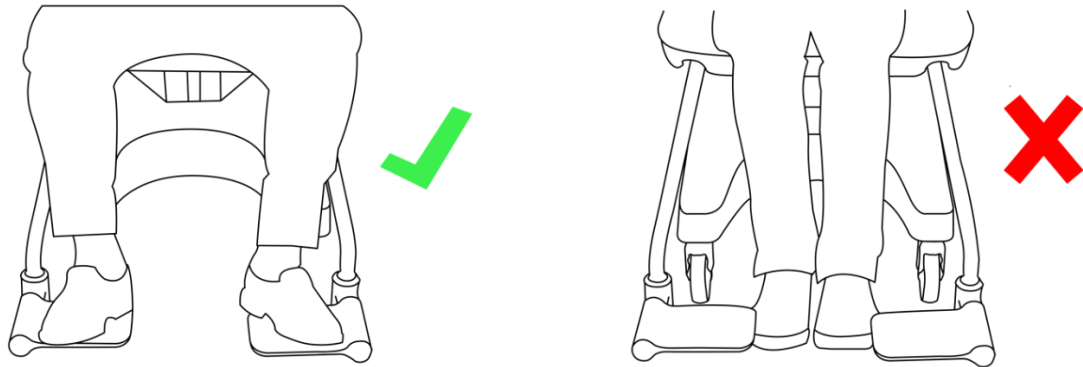

With seat base fully lowered, the patient in the seat and feet are on footrests, the weight reading can be observed.

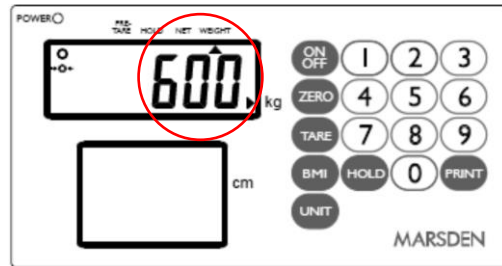

Once the weight reading has been taken, and whilst the patient is being guided out of the seat, feet must be taken off the footrests, footrests rotated out of the way and feet placed firmly on the ground.

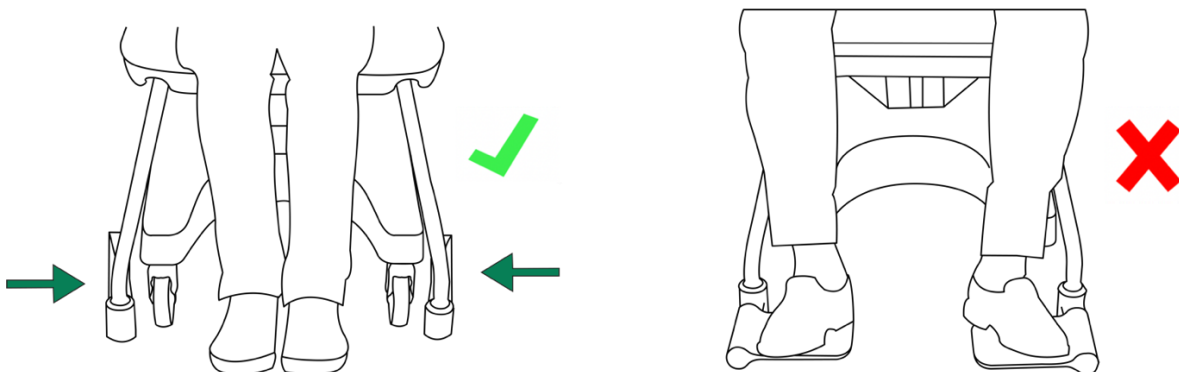

- ⚠ Risk assessments must be carried out before using the scale.
- ⚠ Brakes must be applied on wheels before using the scale.
- ⚠ The seat must be fully lowered for a weight reading to be taken.
- ⚠ Please ensure that use of the M-250 meets your moving and handling/patient safety guidelines.
- ⚠ The M-250's actuator (lifting/lowering mechanism) has a duty cycle. This means that the lifting/lowering mechanism can be used continuously for two minutes followed by 18 minutes of inactivity.

5.2.Switching off the scale

Press the **ON/OFF** button when the scale is turned on. The scale will now power down.

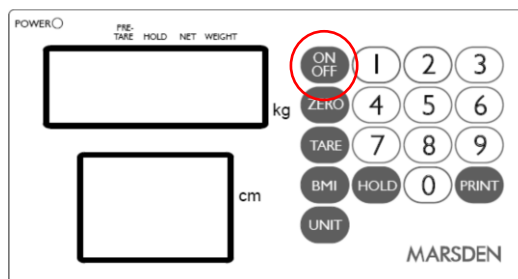

5.3.Setting the Scale to Zero

If for any reason the scale shows a reading other than 0.0kg it can be reset to zero. Press the **ZERO** button once.

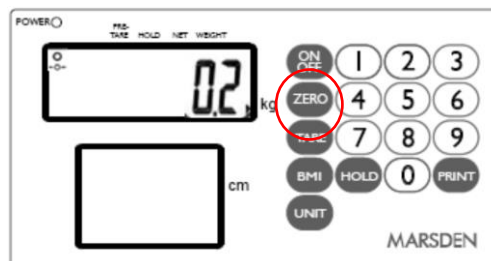

The scale will return to 0.0kg.

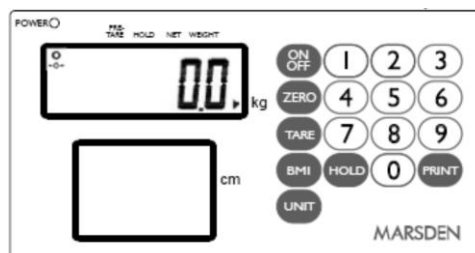

5.4.Using the Hold Function

Press the **HOLD** button once.

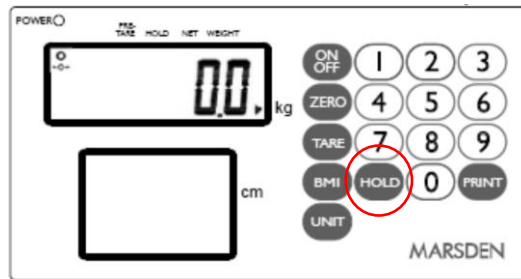

Allow the patient or resident to sit in the scale.

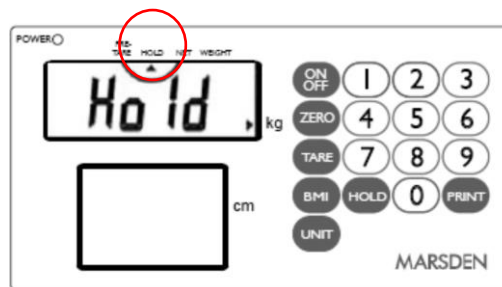

After a few seconds the scale will lock on the person's weight. When the individual leaves the scale, the weight will remain on the display.

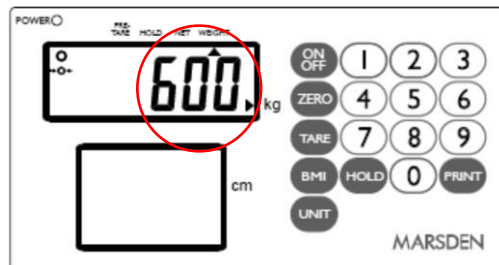

Press **HOLD** again to disable the Hold function and return the scale to 0.0kg.

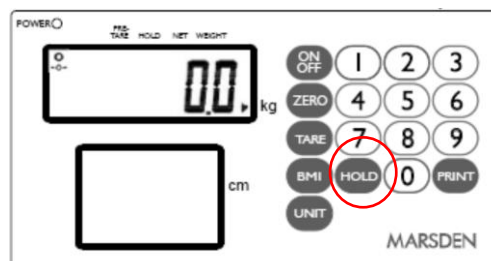

5.5.Using the Body Mass Index (BMI) Function

In normal mode, press the **BMI** button to enter into BMI mode.

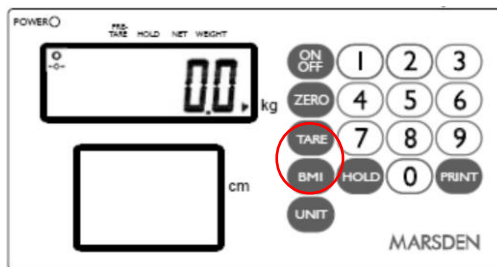

The display will show the last height entered and the extreme left digit will flash. Enter the height by using the numeric keys. Press **ZERO** to confirm the height.

(NB: There will always be an active flashing digit in the height display, unless **HOLD** is pressed).

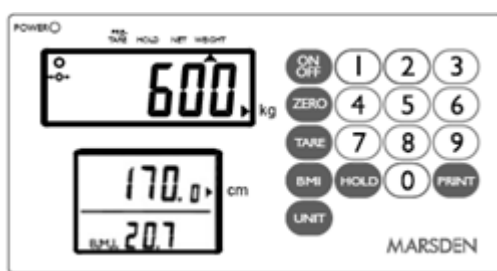

Weigh the patient as normal. The display will show the weight, height and BMI value. At this time, the weight and height can be freely changed, and the BMI value will be automatically calculated according to the changed weight and height.

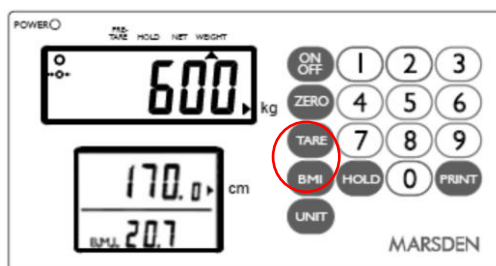

Press **BMI** again to return to normal weighing mode.

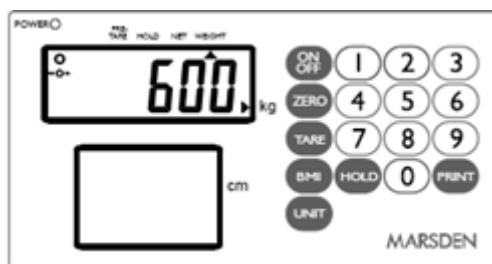

5.6.Using the Tare and Preset Tare Functions

Press **TARE** for three seconds to enter Preset Tare setting mode. When the cursor points to Pre-tare on the display press **TARE** once more. The display will show the last preset tare value entered.

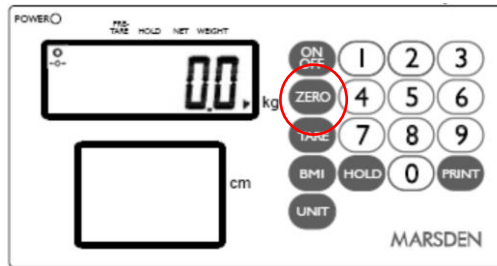

The left digit on the display will flash. Enter the preset tare value by using the numeric keys, then press **TARE** again to confirm the value.

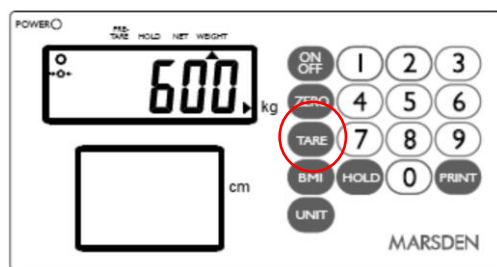

The display will now show the figure you entered deducted from 0.0kg. The scale is now ready to use.

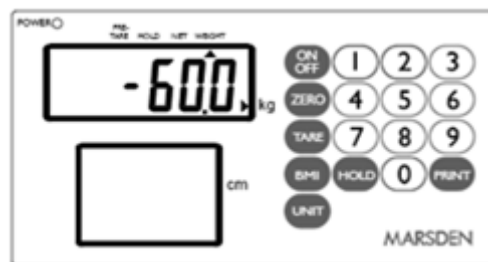

To use the regular Tare function, add the item you wish to tare off to the scale, and press **TARE**. The display will show zero, and then a minus number when the item is removed from the scale.

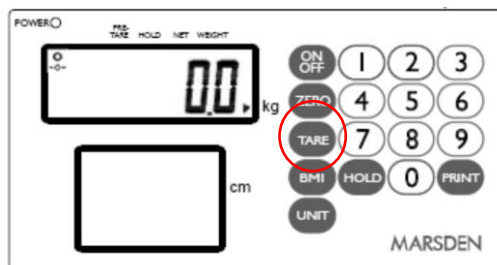

5.7.Setting the Date

Press **HOLD** for three seconds to access the time setting mode. The time period digit that is flashing can be changed by entering the appropriate number from the numeric key pad. The time period to be edited is selected by pressing **HOLD**.

E.g. To input 25 December 2008, 8:00 a.m.:



Enter the year. Press HOLD to confirm and access the date editing field.

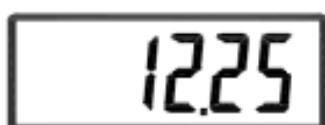

Enter the date. E.g. "12.25" for December 25th. Press HOLD to confirm and access the time clock editing field.



Enter the time (24 hour clock only).

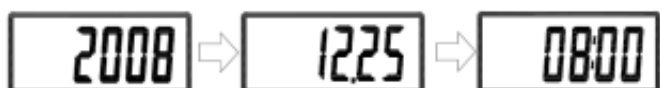

Press HOLD and the display shows:
YYYY→MM.DD→HH:SS



Press HOLD to return to normal weighing mode.

6. Additional Features

6.1. Using the Scale with a Printer

An optional Marsden external thermal printer (model TP-2100) is available for this scale. When the printer is fitted, the patient's weight, height, and BMI result can be printed.

Once the person has been weighed and their BMI calculated, simply press PRINT to produce the following ticket:

GROSS WEIGHT	60.00kg
TARE WEIGHT	30.00kg
NET WEIGHT	30.00kg
PATIENT HEIGHT	100.0cm
PATIENT B.M.I	37.5
29/12/2008 17:00	

In order to connect the printer, plug the cable to the printer, and then connect its 9D connector to the indicator.

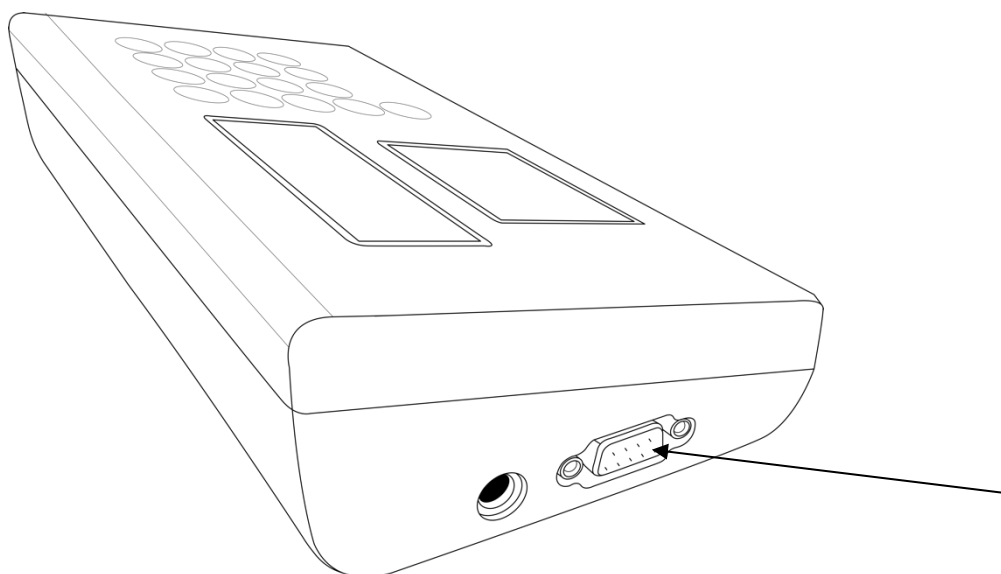

6.2. Using the Scale with a Bluetooth

If your scale has Bluetooth connectivity, the universal Bluetooth symbol will be on the main indicator display.

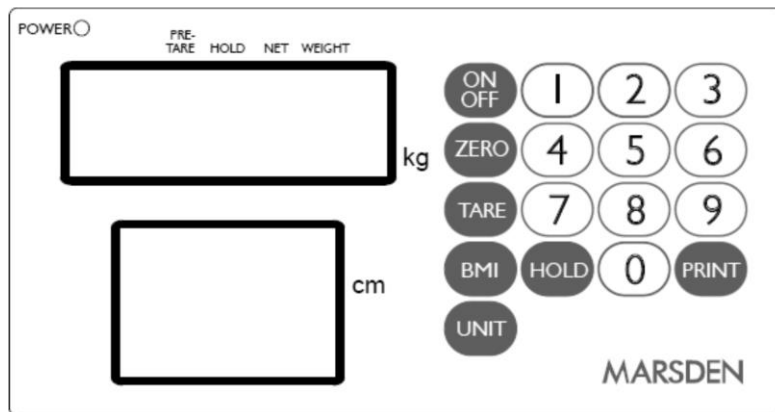

A OFF

Long press **ZERO** for three seconds to enter the Setting mode and then display the A-OFF menu.

bluEt

Press **TARE** twice, and then press **HOLD** once to enter the Bluetooth setting mode.

On ← → OFF

Using **HOLD**, select "ON" (enable) or "OFF" (disable). Press **TARE** to confirm the setting.

Note: Disabling the Bluetooth function when not in use will reduce battery power consumption.

bluEt

Display the "bluEt" menu. Press **TARE** once.

End

Press **HOLD** to return to normal mode.

Search for the scale in your computer or device's Bluetooth settings (procedure may vary depending on device or system)

The scale will appear on the Bluetooth device list as "**MARSDEN BT**".

Connect your device to "**MARSDEN BT**", and the scale is ready to transmit data wirelessly via Bluetooth.

7. EMC Guidance and Manufacturer's Declaration

Guidance and manufacturer's declaration – Electromagnet emissions.

The M-250 is intended for use in the electromagnetic environment specified below. The customer or user of this scale should ensure that it is used in such environment.

Emission Test	Compliance	Electromagnetic environment-guidance
RF emissions CISPR 11	Group 1	This scale uses RF energy only for its internal function. Therefore, its RF emissions are very low and not likely to cause any interference in nearby electronic equipment.
RF emissions CISPR 11	Class B	This scale is suitable for use in all establishments, including domestic establishments and those directly connected to the public low-voltage power supply network that supplies buildings used for domestic purposes.
Harmonic emissions IEC 61000-3-2	Class A	
Voltage fluctuations/flicker emissions IEC 61000-3-3	Compliance	

Guidance and manufacturer's declaration – Electromagnetic immunity.

The M-250 is intended for use in the electromagnetic environment specified below. The customer of the user of this scale should ensure that it is used in such an environment.

Immunity Test	IEC 60601 Test Level	Compliance Level	Electromagnetic Environment Guidance
Electrostatic discharge (ESD) IEC 61000-4-2	± 8 kV contact ± 2 kV, ± 4 kV, ± 8 kV, ± 15 kV air	± 8 kV contact ± 2 kV, ± 4 kV, ± 8 kV, ± 15 kV air	Floors should be wood, cement or ceramic tile. If floors are covered with synthetic material, the relative humidity should be at least 30%.
Electrical fast transient/burst IEC 61000-4-4	± 2kV for power supply lines + 1kV for input/output lines	± 2kV for power supply lines + 1kV for input/output lines	Mains power quality should be that of a typical commercial or hospital environment.
Surge IEC 61000-4-5	± 1kV line(s) to line(s) ± 2kV line(s) to earth	+ 1kV line(s) to line(s) + 2kV line(s) to earth	Mains power quality should be that of a typical commercial or hospital environment.
Voltage Dips, short interruptions and voltage variations on power supply input lines IEC-6100-4-11	0% UT for 0,5 cycle 0% UT for 1 cycle 70% UT(30% dip in UT) for 25 cycles 0% UT for 5 s	0% UT for 0,5 cycle 0% UT for 1 cycle 70% UT(30% dip in UT) for 25 cycles 0% UT for 5 s	Mains power quality should be that of a typical commercial or hospital environment. If the user of this scale requires continued operation during power mains interruptions, it is recommended that this scale is powered from an uninterruptable power supply or a battery.
Power frequency (50/60 Hz) magnetic field IEC 61000-4-8	30 A/m	30 A/m	The scale's power frequency magnetic fields should be at levels characteristic of a typical location in a typical commercial or hospital environment.

Note UT is the A.C mains voltage prior to application of the test level.

Guidance and manufacturer’s declaration – electromagnetic immunity.

This scale is intended for use in the electromagnetic environment specified below. The customer or the user of the scale should ensure that it is used in such an environment.

Immunity Test	IEC 60601 test level	Compliance level	Electromagnetic environment-guidance
<p>Conducted RF IEC61000-4-6</p>	<p>3 Vrms 150 KHz to 80 MHz</p> <p>6 V in ISM bands between 0,15 MHz and 80 MHz 80 % AM at 1 kHz</p>	<p>3 Vrms 150 KHz to 80 MHz</p> <p>6 V in ISM bands between 0,15 MHz and 80 MHz 80 % AM at 1 kHz</p>	<p>Portable and mobile RF communications equipment should be used no closer to any part of the scale including cables, than the recommended separation distance calculated from the equation applicable to the frequency of the transmitter.</p> <p>Recommended separation distance: $d = 1,2 \sqrt{P}$ $d = 1,2 \sqrt{P}$ 80MHz to 800 MHz $d = 2,3 \sqrt{P}$ 800MHz to 2,5 GHz Where P is the maximum output power rating of the transmitter in watts (w) according to the transmitter manufacturer and d is the recommended separation distance in meters (m). Field strengths from fixed RF transmitters, as determined by an electromagnetic site survey, should be less than the compliance level in each frequency range. Interference may occur in the vicinity of equipment marked with the following symbol:</p> 
<p>Radiated RF IEC 61000-4-3</p>	<p>3 V/m 80MHz to 2,7 GHz</p>	<p>3 V/m 80MHz to 2,7 GHz</p>	<p>NOTE1 At 80 MHz and 800 MHz, the higher frequency range applies. NOTE2 These guidelines may not apply in all situations. Electromagnetic propagation is affected by absorption and reflection from structures, objects and people.</p>
<p>A) Field strengths from fixed transmitters, such as base stations for radio (cellular/cordless) telephones and land mobile radios, amateur radio, AM and FM radio broadcast and TV broadcast cannot be predicted theoretically with accuracy. To assess the electromagnetic environment due to fixed RF transmitters, an electromagnetic site survey should be considered. If the measured field strength in the location in which the scale is used exceeds the application RF compliance level above, the scale should be observed to verify normal operation. If abnormal performance is observed, additional measures may be necessary, such as re-orienting or relocating the scale.</p> <p>B) Over the frequency range 150 kHz to 80 MHz, field strengths should be less than 3 V/m.</p>			

Recommended separation distance between portable and mobile RF communications equipment and the M-250.

This scale is intended for use in an electromagnetic environment in which radiated RF disturbances are controlled. The customer or the user of the scale can help prevent electromagnetic interference by maintaining a minimum distance between portable and mobile RF communications equipment (transmitters) and the scale as recommended below, according to the maximum output power of the communications equipment.

Rated maximum output power of transmitter W	Separation distance according to frequency of transmitter m		
	150 kHz to 80 MHz $d = 1,2\sqrt{P}$	80 MHz to 800 MHz $d = 1,2\sqrt{P}$	800 MHz to 2,5 GHz $d = 2,3\sqrt{P}$
0.01	0.12	0.12	0.23
0.1	0.38	0.38	0.73
1	1.2	1.2	2.3
10	3.8	3.8	7.3
100	12	12	23

For transmitters rated at a maximum output power not listed above, the recommended separation distance d in meters (m) can be estimated using the equation applicable to the frequency of the transmitter, where p is the maximum output rating of the transmitter in watts (w) according to the transmitter manufacturer.

NOTE1) At 80 MHz and 800 MHz, the separation distance for the high frequency range applies.

NOTE2) These guidelines may not apply in all situations. Electromagnetic propagation is affected by absorption and reflection from structures, objects and people.

MARSDEN

Declaration of Conformity

Marsden Weighing Machine Group Ltd
Unit 1, Genesis Business Park, Sheffield Road, Rotherham S60 1DX
Telephone – 01709 364296

Manufacturer	Marsden
Category/Product Code	M-250
Accuracy Class	III
Type Approval Certificate	T7618
Test Certificate	TC8334
Notified body issuing the approval for Module B: EU type examination (annex II.1 of 2014/31/EU)	NMI 0122
Notified body issuing the approval for Module D: conformity to type based on quality assurance of the production proves (annex II.2 of 2014/31/EU)	SGS 0120

Conformity to the following Directives is demonstrated by reference to the harmonised standards detailed below.

2014/31/EU	Directive on Non-Automatic Weighing Instrument
2014/30/EU	Electromagnetic Compatibility Directive
2014/35/EU	Low Voltage Directive
2011/65/EU	RoHS Directive
93/42/EEC	Medical Devices Directive Class 1m

Harmonised standards to which conformity is declared
EN60601-1-2: 2014 / EN45501: 2015/ EN50581: 2012

CE 0120



This Declaration of Conformity is issued under the sole responsibility of the manufacturer.



1st January 2020
Richard Black
Managing Director

Manufacturer's Declaration of Conformity

This product has been manufactured in accordance with the harmonized European standards, following the provisions of the below stated directives:

	93/42/EEC as amended by 2007/47/EC Medical Device Directive
	2014/31/EU Non-automatic Weighing Instruments Directive

Please see separate document showing on sticker of device for above CE marking.

Authorized EU Representative:



Obelis s.a.

Bd Général Wahis, 53
B-1030 Brussels
Belgium

DISTRIBUTOR :

MARSDEN

Unit 1, Genesis Business Park, Sheffield Road, Rotherham, UK S60 1DX

Tel: +44 (0) 1709 364296 Fax: +44 (0) 1709 364293

E-mail: sales@marsdengroup.co.uk

Manufactured by:









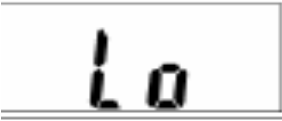

Charder Electronic Co., Ltd.

No.103, Guozhong Rd., Dali Dist.,

Taichung City 412, Taiwan (R.O.C.)

8. Error Messages

<p>Low Battery The scale's alkaline AA type batteries are flat; please replace the batteries.</p>	
<p>Overload This indicates that the scale's load sensor(s) have been overloaded. Reduce the loading and retry.</p>	
<p>Counting Error</p> <ol style="list-style-type: none"> 1. The signal from the load cells is too high. Please remove any weight from the scale and try to power on again. If the scale continues to show the error message, it indicates a fault with the electronics or wiring. 2. The signal from the load cells is too low. Please remove any weight from the scale and try again. If the scale continues to show the error message, it indicates a fault with the electronics or wiring. 	 
<p>High/Low Zero Count</p> <ol style="list-style-type: none"> 1. The scale is above its zero range. Please remove any weight from the scale and power on again. If the scale continues to show the error message, it indicates a fault with the electronics. 2. The scale is below its zero range. Check there is nothing jammed underneath the scale and power on again. If the scale continues to show the error message, it indicates a fault with the electronics. 	 
<p>Seat not fully lowered No weight detected by the scale. Ensure the base of the seat is fully lowered and a weight reading will appear on the display.</p>	
<p>EEPROM Error This indicates there is a fault with the scale's software and is normally caused by a fault with the load cell or wiring. Contact your local service representative.</p>	

MARSDEN

Tel: 01709 364296 / 0800 169 2775

Email: sales@marsdengroup.co.uk

Manufacturing and Distribution:

Unit 7, Centurion Business Park,
Coggin Mill Way,
Rotherham, S60 1FB

Head Office:

Unit 1, Genesis Business Park,
Sheffield Road,
Rotherham, S60 1DX

www.marsden-weighing.co.uk